

---

**Operating Manual**  
**HP 8990A Peak Power**  
**Analyzer**

**SERIAL NUMBERS**

Attached to the rear panel of the instrument is a serial number plate. The serial number is in the form: 0000A00000. the first four digits and the letter are the serial number prefix. The last five digits are the suffix. The prefix is the same for identical instruments; it changes only when a configuration change is made to the instrument. The suffix, however, is assigned sequentially and is different for each instrument.

This manual applies to instruments with serial numbers prefixed 3107A and above.



**Printed in USA**

HP part number: 08990-90032  
Supersedes: December 1992  
Printed in USA April 1997

**Notice.**

The information contained in this document is subject to change without notice.

Hewlett-Packard makes no warranty of any kind with regard to this material, including but not limited to, the implied warranties of merchantability and fitness for a particular purpose. Hewlett-Packard shall not be liable for errors contained herein or for incidental or consequential damages in connection with the furnishing, performance, or use of this material.

© Copyright Hewlett-Packard Company 1991, 1992, 1997

All Rights Reserved. Reproduction, adaptation, or translation without prior written permission is prohibited, except as allowed under the copyright laws.  
1400 Fountaingrove Parkway, Santa Rosa, CA  
95403-1799, USA

---

## HP 8990A Peak Power Analyzer

Hiermit wird bescheinigt, dass dieses Gerät/System in Übereinstimmung mit den Bestimmungen von Postverfügung 1046/84 funkenst“rt ist.”

Der Deutschen Bundespost wurde das Inverkehrbringen dieses Gerätes/System angezeigt und die Berechtigung zur Überprüfung der Serie auf Einhaltung der Bestimmungen eingeräumt.

Zusatzinformation für Mess- und Testgeräte:

Werden Mess- und Testgeräte mit ungeschirmten Kabeln und/oder in offenen Messaufbauten verwendet so ist vom betreiber sicherzustellen dass die Funk-Entst“rbestimmungen unter Betriebsbedingungen an seiner Grundstücksgrenze eingehalten werden.”

---

## Manufacturer's Declaration

This is to certify that this product meets the radio frequency interference requirements of Directive FTZ 1046/1984. The German Bundespost has been notified that this equipment was put into circulation and has been granted the right to check the product type for compliance with these requirements.

**Note:** If test and measurement equipment is operated with unshielded cables and/or used for measurements on open setups, the user must ensure that under these operating conditions, the radio frequency interference limits are met at the border of his premises.

---

## **Certification**

Hewlett-Packard Company certifies that this product met its published specifications at the time of shipment from the factory. Hewlett-Packard further certifies that its calibration measurements are traceable to the United States National Institute of Standards and Technology, to the extent allowed by the Institute's calibration facility, and to the calibration facilities of other International Standards Organization members.

---

## **Warranty**

This Hewlett-Packard instrument product is warranted against defects in material and workmanship for a period of one year from date of shipment. During the warranty period, Hewlett-Packard Company will, at its option, either repair or replace products which prove to be defective.

For warranty service or repair, this product must be returned to a service facility designated by Hewlett-Packard. Buyer shall prepay shipping charges to Hewlett-Packard and Hewlett-Packard shall pay shipping charges to return the product to Buyer. However, Buyer shall pay all shipping charges, duties, and taxes for products returned to Hewlett-Packard from another country.

Hewlett-Packard warrants that its software and firmware designated by Hewlett-Packard for use with an instrument will execute its programming instructions when properly installed on that instrument. Hewlett-Packard does not warrant that the operation of the instrument, or software, or firmware will be uninterrupted or error-free.

#### LIMITATION OF WARRANTY

The foregoing warranty shall not apply to defects resulting from improper or inadequate maintenance by Buyer, Buyer-supplied software or interfacing, unauthorized modification or misuse, operation outside of the environmental specifications for the product, or improper site preparation or maintenance.

NO OTHER WARRANTY IS EXPRESSED OR IMPLIED. HEWLETT-PACKARD SPECIFICALLY DISCLAIMS THE IMPLIED WARRANTIES OF MERCHANTABILITY AND FITNESS FOR A PARTICULAR PURPOSE.

#### EXCLUSIVE REMEDIES

THE REMEDIES PROVIDED HEREIN ARE BUYER'S SOLE AND EXCLUSIVE REMEDIES. HEWLETT-PACKARD SHALL NOT BE LIABLE FOR ANY DIRECT, INDIRECT, SPECIAL, INCIDENTAL, OR CONSEQUENTIAL DAMAGES, WHETHER BASED ON CONTRACT, TORT, OR ANY OTHER LEGAL THEORY.

---

### **Assistance**

Product maintenance agreements and other customer assistance agreements are available for Hewlett-Packard products. For any assistance, contact your nearest Hewlett-Packard Sales and Service Office. Addresses are provided on the following page.

## Hewlett-Packard Sales and Service Offices

US FIELD OPERATIONS		
<p><b>Headquarters</b> Hewlett-Packard Co. 19320 Pruneridge Avenue Cupertino, CA 95014 (800) 752-0900</p>	<p><b>California, Northern</b> Hewlett-Packard Co. 301 E. Evelyn Mountain View, CA 94041 (415) 694-2000</p>	<p><b>California, Southern</b> Hewlett-Packard Co. 1421 South Manhattan Ave. Fullerton, CA 92631 (714) 999-6700</p>
<p><b>Colorado</b> Hewlett-Packard Co. 24 Inverness Place, East Englewood, CO 80112 (303) 649-5512</p>	<p><b>Atlanta Annex</b> Hewlett-Packard Co. 2124 Barrett Park Drive Kennesaw, GA 30144 (404) 648-0000</p>	<p><b>Illinois</b> Hewlett-Packard Co. 5201 Tollview Drive Rolling Meadows, IL 60008 (708) 255-9800</p>
<p><b>New Jersey</b> Hewlett-Packard Co. 150 Green Pond Rd. Rockaway, NJ 07866 (201) 586-5400</p>	<p><b>Texas</b> Hewlett-Packard Co. 930 E. Campbell Rd. Richardson, TX 75081 (214) 231-6101</p>	
EUROPEAN FIELD OPERATIONS		
<p><b>Headquarters</b> Hewlett-Packard S.A. 150, Route du Nant-d'Avril 1217 Meyrin 2/Geneva Switzerland (41 22) 780.8111</p>	<p><b>France</b> Hewlett-Packard France 1 Avenue Du Canada Zone D'Activite De Courtaboeuf F-91947 Les Ulis Cedex France (33 1) 69 82 60 60</p>	<p><b>Germany</b> Hewlett-Packard GmbH Hewlett-Packard Strasse 61352 Bad Homburg v.d.H Germany (49 6172) 16-0</p>
<p><b>Great Britain</b> Hewlett-Packard Ltd. Eskdale Road, Winnersh Triangle Wokingham, Berkshire RG41 5DZ England (44 734) 696622</p>		

## Hewlett-Packard Sales and Service Offices

INTERCON FIELD OPERATIONS		
<p><b>Headquarters</b>                      Hewlett-Packard Company                      3495 Deer Creek Road                      Palo Alto, California, USA                      94304-1316                      (415) 857-5027</p>	<p><b>Australia</b>                      Hewlett-Packard Australia Ltd.                      31-41 Joseph Street                      Blackburn, Victoria 3130                      (61 3) 895-2895</p>	<p><b>Canada</b>                      Hewlett-Packard (Canada) Ltd.                      17500 South Service Road                      Trans-Canada Highway                      Kirkland, Quebec H9J 2X8                      Canada                      (514) 697-4232</p>
<p><b>China</b>                      China Hewlett-Packard Company                      38 Bei San Huan X1 Road                      Shuang Yu Shu                      Hai Dian District                      Beijing, China                      (86 1) 256-6888</p>	<p><b>Japan</b>                      Hewlett-Packard Japan, Ltd.                      1-27-15 Yabe, Sagamihara                      Kanagawa 229, Japan                      (81 427) 59-1311</p>	<p><b>Singapore</b>                      Hewlett-Packard Singapore (Pte.) Ltd.                      150 Beach Road                      #29-00 Gateway West                      Singapore 0718                      (65) 291-9088</p>
<p><b>Taiwan</b>                      Hewlett-Packard Taiwan                      8th Floor, H-P Building                      337 Fu Hsing North Road                      Taipei, Taiwan                      (886 2) 712-0404</p>		

---

## **General Safety Considerations**

This Product and related documentation must be reviewed for familiarization with safety markings and instructions before operation.

This product is a Safety Class I system (provided with a protective earth terminal).

### **Before Applying Power**

Verify that the product is set to match the available line voltage and the correct fuses are installed.

### **Safety Earth Ground**

An uninterruptable safety earth ground must be provided from the main power source to the product input wiring terminals, power cable, or supplied power cable set.

### **Warning**

**Any interruption of the protective (grounding) conductor (inside or outside the system) or disconnecting the protective earth terminal will cause a potential shock hazard that could result in personal injury. (Grounding one conductor of a two conductor outlet is not sufficient protection.) In addition, verify that a common ground exists between the unit under test and the system prior to energizing either unit.**

**Whenever it is likely that the protection has been impaired, the system must be made inoperative and be secured against any unintended operation.**

**If this system is to be energized via an autotransformer (for voltage reduction) make sure the common terminal is connected to neutral (that is, the grounded side of the mains supply.)**

**Servicing instructions are for use by service-trained personnel only. To avoid dangerous electric shock, do not perform any servicing unless qualified to do so.**

**Adjustments described in the manual are performed with power supplied to the system's instruments while**



protective covers are removed. Energy available at many points may, if contacted, result in personal injury.

Capacitors inside the system's instruments might still be charged even if the system has been disconnected from its source of supply.

For continued protection against fire hazard, replace the line fuses only with 250V fuses of the same current rating and type (for example, normal blow, time delay, etc.). Do not use repaired fuses or short circuited fuse holders.

---

**Safety Symbols**



Instruction manual symbol: The product will be marked with this symbol when it is necessary for the user to refer to the instruction manual. (See Table of Contents for page references.)



Indicates hazardous voltages.



Indicates earth (ground) terminal.

---

**Warning**

**Warning denotes a hazard. It calls attention to a procedure, practice or the like which, if not correctly performed or adhered to, could result in personal injury. Do not proceed beyond a WARNING sign until the indicated conditions are fully understood and met.**

---

**Caution**

Caution denotes a hazard. It calls attention to a procedure, practice or the like which, if not correctly performed or adhered to, could result in damage to or destruction of part or all of the product. Do not proceed beyond a CAUTION sign until the indicated conditions are fully understood and met.

---

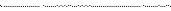
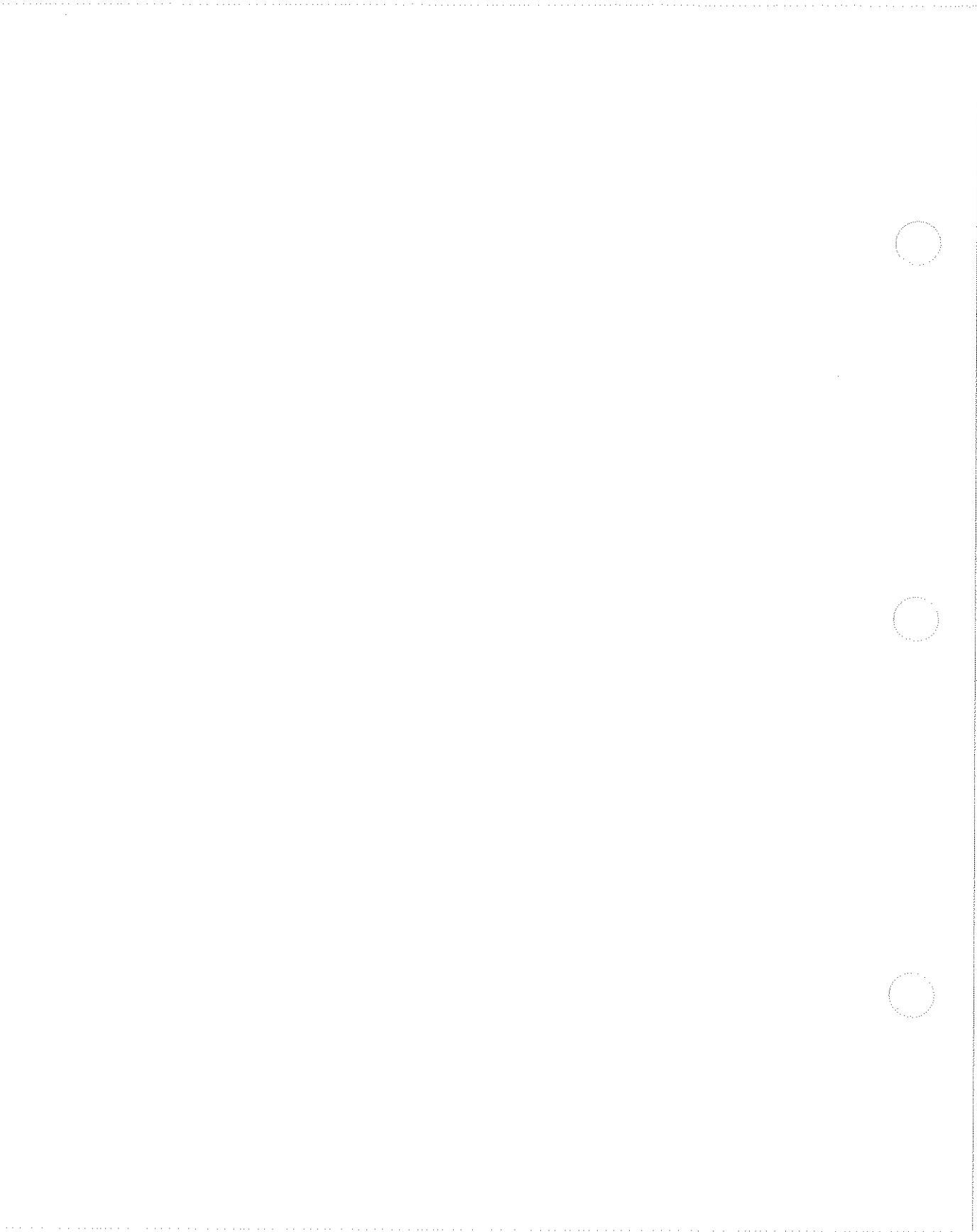

# Contents

---

<b>1. General Information</b>	
. . . . .	1-1
Introduction . . . . .	1-1
Specifications . . . . .	1-2
Safety Considerations . . . . .	1-2
Instruments Covered By This Manual . . . . .	1-4
Manual Change Package . . . . .	1-4
Description . . . . .	1-4
Options . . . . .	1-5
Electrical Options . . . . .	1-5
Single Sensor Input (Option 001) . . . . .	1-5
Rear Panel Sensor Inputs (Option 002) . . . . .	1-5
Miscellaneous Options . . . . .	1-5
Service Manual (Option 915) . . . . .	1-5
Additional User Documentation (Option 916) . . . . .	1-5
Additional Programming Manual or Getting Started Guide . . . . .	1-6
Accessories Supplied . . . . .	1-6
Accessories Available . . . . .	1-6
Electrical . . . . .	1-6
30 dB Attenuator . . . . .	1-6
APC-3.5 mm Adapter . . . . .	1-6
2.4 mm Adapter . . . . .	1-6
Mechanical . . . . .	1-7
Rack Mount Assembly . . . . .	1-7
Recommended Test Equipment . . . . .	1-7

<b>2. Installation and Operator's Maintenance</b>	
Introduction . . . . .	2-1
Initial Inspection . . . . .	2-1
Power Requirements . . . . .	2-2
Line Voltage and Fuse Selection . . . . .	2-3
Selecting the Line Voltage . . . . .	2-3
Checking for the Correct Fuse . . . . .	2-3
Power Cables . . . . .	2-5
Interconnections . . . . .	2-7
. . . . .	2-7
Hewlett-Packard Interface Bus . . . . .	2-7
Peak Power Sensor . . . . .	2-7
Mating Connectors . . . . .	2-7
. . . . .	2-7
HP-IB Interface Connector. . . . .	2-7
Coaxial Connector . . . . .	2-7
Type N Connector . . . . .	2-8
Peak Power Sensor Input . . . . .	2-8
Turn-on Instructions . . . . .	2-8
Turn-On Procedure . . . . .	2-8
Power-up Sequence . . . . .	2-9
Intensity Control . . . . .	2-10
Operator's Checks . . . . .	2-10
Self-Tests . . . . .	2-11
Procedure . . . . .	2-11
Front Panel Checks . . . . .	2-12
Equipment . . . . .	2-12
HP-IB Address Selection . . . . .	2-14
Operating Environment . . . . .	2-16
Bench Operation . . . . .	2-16
Rack Mounting . . . . .	2-16
Storage and Shipment . . . . .	2-17
. . . . .	2-17
Environment . . . . .	2-17
Packaging . . . . .	2-17
Tagging for Service . . . . .	2-17
Original Packaging . . . . .	2-17
Other Packaging . . . . .	2-18

Operator's Maintenance Procedures . . .	2-20
<b>3. Local Operation</b>	
Introduction . . . . .	3-1
Turn-on Instructions . . . . .	3-1
Turn-On Procedure . . . . .	3-2
Power-up Sequence . . . . .	3-2
Instrument Preset . . . . .	3-4
Instrument Overview . . . . .	3-7
Front Panel . . . . .	3-7
System Control . . . . .	3-8
RUN/STOP . . . . .	3-9
SINGLE . . . . .	3-10
CLEAR DISPLAY . . . . .	3-10
LOCAL . . . . .	3-10
HARDCOPY . . . . .	3-10
Setup . . . . .	3-11
AUTOSCALE . . . . .	3-12
RECALL . . . . .	3-14
SAVE . . . . .	3-14
SHOW . . . . .	3-14
Entry . . . . .	3-16
Numeric Keypad . . . . .	3-17
KNOB . . . . .	3-17
FINE . . . . .	3-17
Input . . . . .	3-18
Sensor Check Source . . . . .	3-18
Display . . . . .	3-18
Menus . . . . .	3-19
<b>3. Timebase Menu</b>	
Introduction to the Timebase . . . . .	3-25
Time/Div Key . . . . .	3-26
delay Key . . . . .	3-27
reference Key . . . . .	3-27
Window Key . . . . .	3-28
timebase Key . . . . .	3-29
position Key . . . . .	3-29

Window example . . . . .	3-29
Setting the Peak Power Analyzer . . . . .	3-30
Viewing the Window . . . . .	3-31
<b>3. Channel Menu</b>	
Introduction to Channels . . . . .	3-33
Channel Key . . . . .	3-35
Channels 1 and 4 . . . . .	3-35
Vertical scale key . . . . .	3-35
reference level Key ( <i>log mode only</i> ) . . . . .	3-36
Bandwidth Key . . . . .	3-36
external loss Key . . . . .	3-37
sensor zero . . . . .	3-37
Channels 2 and 3 . . . . .	3-38
Vertical Sensitivity Key . . . . .	3-38
offset Key . . . . .	3-39
coupling Key . . . . .	3-39
more (preset, probe) Key . . . . .	3-39
Channel (more) Key . . . . .	3-39
probe Key . . . . .	3-39
ECL Key . . . . .	3-40
TTL Key . . . . .	3-40
more Key . . . . .	3-40
<b>3. Trigger Menu</b>	
Introduction to the Triggers . . . . .	3-41
Single Sensor Input Option . . . . .	3-41
Triggering Internally or Externally . . . . .	3-42
Trigger Mode Interaction . . . . .	3-43
Edge Trigger Mode . . . . .	3-43
Trig'd/auto Key . . . . .	3-44
source Key . . . . .	3-45
level Key . . . . .	3-45
slope Key . . . . .	3-45
holdoff Key . . . . .	3-45
Holdoff Exercise . . . . .	3-46
Pulse Generator Setup . . . . .	3-46
Peak Power Analyzer Setup . . . . .	3-46

Pattern Trigger Mode . . . . .	3-50
pattern Key . . . . .	3-51
when Key . . . . .	3-51
holdoff Key . . . . .	3-52
Pattern Trigger Exercise . . . . .	3-53
Pulse Generator Setup . . . . .	3-53
Peak Power Analyzer Setup . . . . .	3-54
State Trigger Mode . . . . .	3-58
clock Key . . . . .	3-59
when Key . . . . .	3-59
present Key . . . . .	3-60
holdoff Key . . . . .	3-60
State Trigger Exercise . . . . .	3-60
Pulse Generator Setup . . . . .	3-61
Peak Power Analyzer Setup . . . . .	3-61
Delay Trigger Mode . . . . .	3-64
qualify on Key . . . . .	3-65
edge Qualify Option . . . . .	3-66
pattern Qualify Option . . . . .	3-66
state Qualify Option . . . . .	3-66
delay Key . . . . .	3-67
trigger on Key . . . . .	3-68
Delay Trigger Exercise . . . . .	3-68
Pulse Generator Setup . . . . .	3-68
Peak Power Analyzer Setup . . . . .	3-69

### 3. Display Menu

Introduction to the Display . . . . .	3-75
Display Mode Key . . . . .	3-76
norm . . . . .	3-76
avg . . . . .	3-77
env . . . . .	3-77
power display Key . . . . .	3-78
no. of screens Key . . . . .	3-78
off/frame/ axis/grid Key . . . . .	3-80
connect dots Key . . . . .	3-80

<b>3. Markers Menu</b>	
Introduction to Markers . . . . .	3-83
ampl markers . . . . .	3-85
marker 2 . . . . .	3-85
marker 1 . . . . .	3-85
time markers . . . . .	3-86
start marker . . . . .	3-86
stop marker . . . . .	3-86
ampl @ time mkrs . . . . .	3-87
<b>3. Carrier Frequency Menu</b>	
Introduction to the Carrier Frequency . .	3-89
Channel Selector Key . . . . .	3-90
Channels 1 and 4 coupled . . . . .	3-90
Channels 1 and 4 separate . . . . .	3-90
<b>3. Waveform Math Menu</b>	
Introduction to the Functions . . . . .	3-91
Single Sensor Input Option . . . . .	3-93
Defining a Function . . . . .	3-93
Function Key . . . . .	3-93
display Key . . . . .	3-93
chan/mem Key . . . . .	3-94
Operator Key . . . . .	3-94
chan/mem Key . . . . .	3-95
sensitivity Key . . . . .	3-95
offset Key . . . . .	3-95
Vertical Scaling Units . . . . .	3-95
Displaying Functions . . . . .	3-96
Waveform Math Exercise . . . . .	3-98
Analyzer Setup . . . . .	3-98



<b>3. Waveform Memory Menu</b>	
Introduction to the Memories . . . . .	3-101
waveform/pixel Key . . . . .	3-102
waveform Menu . . . . .	3-102
nonvolatile Key . . . . .	3-102
display Key . . . . .	3-103
source Key . . . . .	3-103
store Key . . . . .	3-103
pixel Menu . . . . .	3-103
volatile Key . . . . .	3-103
display Key . . . . .	3-104
clear memory Key . . . . .	3-104
add to memory Key . . . . .	3-104
Waveform Memory Exercise . . . . .	3-104
Analyzer Setup . . . . .	3-104
<b>3. Define Measure Menu</b>	
Introduction to Measurements . . . . .	3-107
Measurement Selection . . . . .	3-109
meas/meas def/meas limit Key . . . . .	3-110
Measure Sub-menu . . . . .	3-111
continuous Key . . . . .	3-111
statistics Key . . . . .	3-111
Measure Define Sub-menu . . . . .	3-111
standard/user defined Key . . . . .	3-111
thresholds measurements Key . . . . .	3-112
Measure Limit Sub-menu . . . . .	3-114
test Key . . . . .	3-114
set Key . . . . .	3-114
fail if > Key . . . . .	3-115
or if < Key . . . . .	3-115
save to Key . . . . .	3-115
after fail Key . . . . .	3-115

<b>3. Utility Menu</b>	
Introduction to the Utilities . . . . .	3-117
HP-IB Menu . . . . .	3-119
talk only mode . . . . .	3-120
addressed mode . . . . .	3-120
EOI Key . . . . .	3-120
form feed Key . . . . .	3-121
paper length Key . . . . .	3-121
exit menu Key . . . . .	3-121
clicker Key . . . . .	3-121
check source Key . . . . .	3-122
show status menu . . . . .	3-122
update Key . . . . .	3-123
more Key . . . . .	3-123
selftest menu . . . . .	3-123
ram Test . . . . .	3-125
rom Test . . . . .	3-126
acquisition Test . . . . .	3-126
miscellaneous Tests . . . . .	3-126
loop Test . . . . .	3-126
start test Key . . . . .	3-126
test all Key . . . . .	3-126
exit menu Key . . . . .	3-126
Order of Calibrations . . . . .	3-127
Calibrating to meet Specified Accuracy	3-127
The Peak Power Analyzer has been	
Serviced . . . . .	3-127
Probe Cal . . . . .	3-128
Time Null . . . . .	3-128
probe cal Menu . . . . .	3-128
attenuation submenu . . . . .	3-129
channel Key . . . . .	3-130
start cal Key . . . . .	3-130
continue Key . . . . .	3-130
abort Key . . . . .	3-130
exit menu Key . . . . .	3-131
time null submenu . . . . .	3-131
channel Key . . . . .	3-131

time Key . . . . .	3-131
exit menu Key . . . . .	3-131
instr cal menu . . . . .	3-132
cal select Key . . . . .	3-134
channel Key . . . . .	3-134
start cal Key . . . . .	3-134
Vertical Cal . . . . .	3-134
Delay Cal . . . . .	3-135
continue Key . . . . .	3-135
abort Key . . . . .	3-136
exit menu Key . . . . .	3-136
If Calibration Fails . . . . .	3-136
service menu . . . . .	3-137
Default Cal . . . . .	3-137
Logic Trigger Delay Cal . . . . .	3-137
more Key . . . . .	3-138

**4. Performance Tests**

Introduction . . . . .	4-1
Equipment Required . . . . .	4-1
Performance Test Record . . . . .	4-1
Calibration Cycle . . . . .	4-1
Performance Test Procedures . . . . .	4-2
Checking Risetime/Falltime . . . . .	4-3
Specification . . . . .	4-3
Description . . . . .	4-3
Equipment . . . . .	4-4
Procedure . . . . .	4-4
To set up the test equipment . . . . .	4-4
To set up the Peak Power Analyzer . . . . .	4-5
To verify the 5 ns risetime . . . . .	4-6
To verify all Channel 1 and 4 risetimes . . . . .	4-8
To verify the risetime of Channels 2 and 3 . . . . .	4-8
Checking Power Measurement Range . . . . .	4-10
Specification . . . . .	4-10
Description . . . . .	4-10
Equipment . . . . .	4-10

Procedure . . . . .	4-11
To set up the test equipment . . . . .	4-11
To set up the Analyzer . . . . .	4-12
To calibrate power . . . . .	4-13
To zero the sensor . . . . .	4-14
To verify measurement accuracy at -32 dBm . . . . .	4-14
To check power measurement range accuracy . . . . .	4-15
Checking Instrumentation Uncertainty . . . . .	4-17
Specification . . . . .	4-17
Description . . . . .	4-17
Controllers . . . . .	4-17
Operating System . . . . .	4-18
Equipment . . . . .	4-18
Installing the Software . . . . .	4-19
Using a Floppy Disc Drive . . . . .	4-19
Using a Shared Resource Management (SRM) or Hierarchical File System (HFS) Hard Disc . . . . .	4-19
Running the Software . . . . .	4-19
Checking Sensor Check Source Power Level . . . . .	4-24
Specification . . . . .	4-24
Description . . . . .	4-24
Equipment . . . . .	4-24
Procedure . . . . .	4-25
To set up the equipment . . . . .	4-25
To measure sensor check source power . . . . .	4-25
Checking Bandwidth . . . . .	4-27
Specification . . . . .	4-27
Description . . . . .	4-27
Equipment . . . . .	4-27
Procedure . . . . .	4-28
To set up the test equipment and Peak Power Analyzer . . . . .	4-28
To verify the bandwidth limits of Channels 2 and 3 . . . . .	4-28
Checking Offset Accuracy . . . . .	4-30

Specification . . . . .	4-30
Description . . . . .	4-30
Equipment Required . . . . .	4-30
Procedure . . . . .	4-31
To set up the test equipment and the Peak Power Analyzer . . . . .	4-31
To verify offset accuracy for Channel 2	4-31
To verify offset accuracy for Channel 3	4-32
Checking Channel 1 and Channel 4 Trigger	
Sensitivity . . . . .	4-34
Specification . . . . .	4-34
Description . . . . .	4-34
Equipment . . . . .	4-35
Procedure . . . . .	4-35
To set up the test equipment and the Peak Power Analyzer . . . . .	4-35
To measure power with the Peak Power Analyzer . . . . .	4-36
To verify internal triggering down to 0.25 of full scale . . . . .	4-37
To verify triggering for a $-30$ dBm signal . . . . .	4-37
Checking Channel 2 and 3 Trigger	
Sensitivity . . . . .	4-39
Specification . . . . .	4-39
Description . . . . .	4-39
Equipment . . . . .	4-40
Procedure . . . . .	4-40
To set up the test equipment and the Peak Power Analyzer . . . . .	4-40
To check Channel 2 and 3 trigger sensitivity from dc to 1 MHz . . . . .	4-40
To check Channel 2 and 3 trigger sensitivity from 1 MHz to 100 MHz	4-41
Checking Delta-t Accuracy . . . . .	4-42
Specification . . . . .	4-42
Description . . . . .	4-42
Equipment . . . . .	4-43

Procedure . . . . .	4-43
To set up the test equipment and the Peak Power Analyzer . . . . .	4-43
Using the markers to measure delta t	4-44
<b>A. Algorithms</b>	
Introduction . . . . .	A-1
Measurement Setup . . . . .	A-1
Making Measurements . . . . .	A-2
Automatic Top-Base . . . . .	A-2
Edge Definition . . . . .	A-3
Algorithm Definitions . . . . .	A-4
delay . . . . .	A-4
Pulse Width . . . . .	A-5
Offtime . . . . .	A-5
PRI . . . . .	A-6
PRF . . . . .	A-6
Duty Cycle . . . . .	A-6
Risetime . . . . .	A-6
Falltime . . . . .	A-6
Overshoot . . . . .	A-6
V <sub>max</sub> . . . . .	A-7
V <sub>min</sub> . . . . .	A-7
V <sub>p-p</sub> . . . . .	A-7
V <sub>top</sub> . . . . .	A-7
V <sub>base</sub> . . . . .	A-7
V <sub>amp</sub> . . . . .	A-7
V <sub>avg</sub> . . . . .	A-7
V <sub>rms</sub> . . . . .	A-7

**Index**

## Figures

---

1-1. HP 8990A Peak Power Analyzer with Accessories Supplied . . . . .	1-3
2-1. Selecting the Line Voltage . . . . .	2-4
2-2. Checking for the Correct Fuse . . . . .	2-4
2-3. Power Cable and Line (Mains) Plug Part Numbers . . . . .	2-6
3-1. HP 8990A Front Panel . . . . .	3-8
3-2. System Control Section . . . . .	3-9
3-3. Setup Section . . . . .	3-12
3-4. Show Key . . . . .	3-15
3-5. Entry Section . . . . .	3-16
3-6. Function Keys . . . . .	3-19
3-7. Menus Section . . . . .	3-20
3-8. Rear Panel Features . . . . .	3-21
3-9. Timebase Menu . . . . .	3-25
3-10. Input Signal for Window Viewing . . . . .	3-30
3-11. Input Signal with Window Turned on . . . . .	3-31
3-12. HP 8990A Channel Menu . . . . .	3-34
3-13. Edge Trigger Menu . . . . .	3-44
3-14. Two-Burst Waveform after Autoscale . . . . .	3-47
3-15. Two-Burst Pulse . . . . .	3-48
3-16. Two-Burst Pulse w/Stable Trigger . . . . .	3-49
3-17. Pattern Trigger Menu . . . . .	3-50
3-18. XHLX when entered Pattern . . . . .	3-55
3-19. XHLX when exited Pattern . . . . .	3-56
3-20. XHHX when entered Pattern . . . . .	3-57
3-21. XHHX when exited Pattern . . . . .	3-58
3-22. State Trigger Menu . . . . .	3-59
3-23. X↑LX State . . . . .	3-63
3-24. X↓HX State . . . . .	3-64

3-25. Delay Trigger Menu . . . . .	3-65
3-26. Ten Burst Pulse after AUTOSCALE . . . . .	3-69
3-27. Ten Burst Pulse w/Stable Trigger . . . . .	3-71
3-28. Ten Burst Pulse Triggered on Pulse 5 . . . . .	3-72
3-29. Ten Burst Pulse Triggered on Pulse 9 . . . . .	3-72
3-30. Display Menu . . . . .	3-75
3-31. Dual Screen Display . . . . .	3-79
3-32. Quad Screen Display . . . . .	3-79
3-33. Connect the Dots . . . . .	3-81
3-34. Markers Menu . . . . .	3-84
3-35. Carrier Frequency Menu . . . . .	3-89
3-36. Waveform Math Menu . . . . .	3-92
3-37. Single Screen w/Function On . . . . .	3-96
3-38. Dual Screen w/Function On . . . . .	3-97
3-39. Quad Screen w/Function On . . . . .	3-97
3-40. Waveform Memory 1 minus Channel 1 . . . . .	3-99
3-41. Waveform Memory Menu . . . . .	3-101
3-42. Displayed Memory . . . . .	3-106
3-43. Define Measure Menu . . . . .	3-108
3-44. Utility Menu . . . . .	3-118
3-45. HP-IB Menu . . . . .	3-120
3-46. Selftest Menu . . . . .	3-124
3-47. Results of Selftest . . . . .	3-125
3-48. Probe Cal Menu . . . . .	3-129
3-49. Instrument Cal Options . . . . .	3-132
4-1. Checking Channel 1 and Channel 4 Risetime Equipment Setup . . . . .	4-4
4-2. Checking Channel 2 and Channel 3 Risetime Equipment Setup . . . . .	4-8
4-3. Checking Power Measurement Range Equipment Setup . . . . .	4-11
4-4. Peak Power Sensor Cable Electrical Connector . . . . .	4-20
4-6. Checking Sensor Check Source Equipment Setup . . . . .	4-24
4-7. Checking Bandwidth Equipment Setup . . . . .	4-27
4-8. Checking Offset Accuracy Equipment Setup . . . . .	4-30



4-9. Checking Channel 1 and Channel 4 Trigger Sensitivity Equipment Setup	4-34
4-10. Checking Channel 2 and Channel 3 Trigger Sensitivity Equipment Setup	4-39
4-11. Checking Delta-t Accuracy Equipment Setup . . . . .	4-42
4-12. Mid-Screen Crossover . . . . .	4-44

## Tables

---

1-1. Specifications . . . . .	1-8
1-1. Specifications (continued) . . . . .	1-9
1-1. Specifications (continued) . . . . .	1-10
1-1. Specifications (continued) . . . . .	1-11
1-1. Specifications (continued) . . . . .	1-12
1-1. Specifications (continued) . . . . .	1-13
1-1. Specifications (continued) . . . . .	1-14
1-2. Calculating Overall Power Measurement Accuracy . . . . .	1-15
1-3. Recommended Test Equipment . . . . .	1-16
2-1. Fuse Ratings and Part Numbers . . . . .	2-3
2-2. Allowable HP-IB Address Codes . . . . .	2-15
3-1. Preset Default Conditions . . . . .	3-5
4-1. Risetime/Falltime Settings and Expected Measurement Results . . . . .	4-5
4-2. Average Power Versus Measured Power . . . . .	4-13
4-3. Performance Test Record . . . . .	4-46

## General Information

---

**Introduction** The HP 8990A Peak Power Analyzer operating and service documentation consists of a *Getting Started Guide*, *Operating Manual*, *Programming Manual*, and a *Service Manual*. These four volumes contain all the information required to install, operate, test, adjust and service the Peak Power Analyzer.

The Operating Manual, which is shipped with each instrument, contains information covering the following:

- General Information
- Installation
- Operation
- Performance Tests

The *Getting Started Guide* quickly helps the user become familiar with the basic functions of the Peak Power Analyzer. The *Programming Manual* contains all the necessary information to operate the Peak Power Analyzer remotely. Both the *Getting Started Guide* and *Programming Manual* are shipped with each instrument.

The Service Manual can be ordered with the Peak Power Analyzer as Option 915. The *Service Manual* contains the following sections:

- Service Introduction
- Repair
- Calibration
- Reference

In the United States and Canada, additional copies of the *Operating Manual*, *Getting Started Guide*, *Programming Manual*, or the *Service Manual* may be ordered separately by calling Hewlett-Packard's Direct Marketing Division at **1-800-538-8787**. In Europe, additional copies of the documentation may be obtained by calling your nearest Hewlett-Packard office. The part numbers of the manuals are listed on the title page of this manual.

**Specifications**

Warranted and supplemental specifications are listed in Table 1-1. Warranted specifications are the performance standards or limits against which the instrument may be tested. Supplemental characteristics are not warranted specifications, but are typical characteristics included as additional information for the user.

**Safety Considerations**

This product is a Safety Class I instrument, meaning, one that is provided with a protective earth terminal. The Peak Power Analyzer and all related documentation should be reviewed for familiarization with safety markings and instructions before operation. Refer to the Safety considerations page found at the beginning of this manual for a summary of the safety information. Safety information for installation, operation, and performance testing, is found in appropriate places throughout this manual.

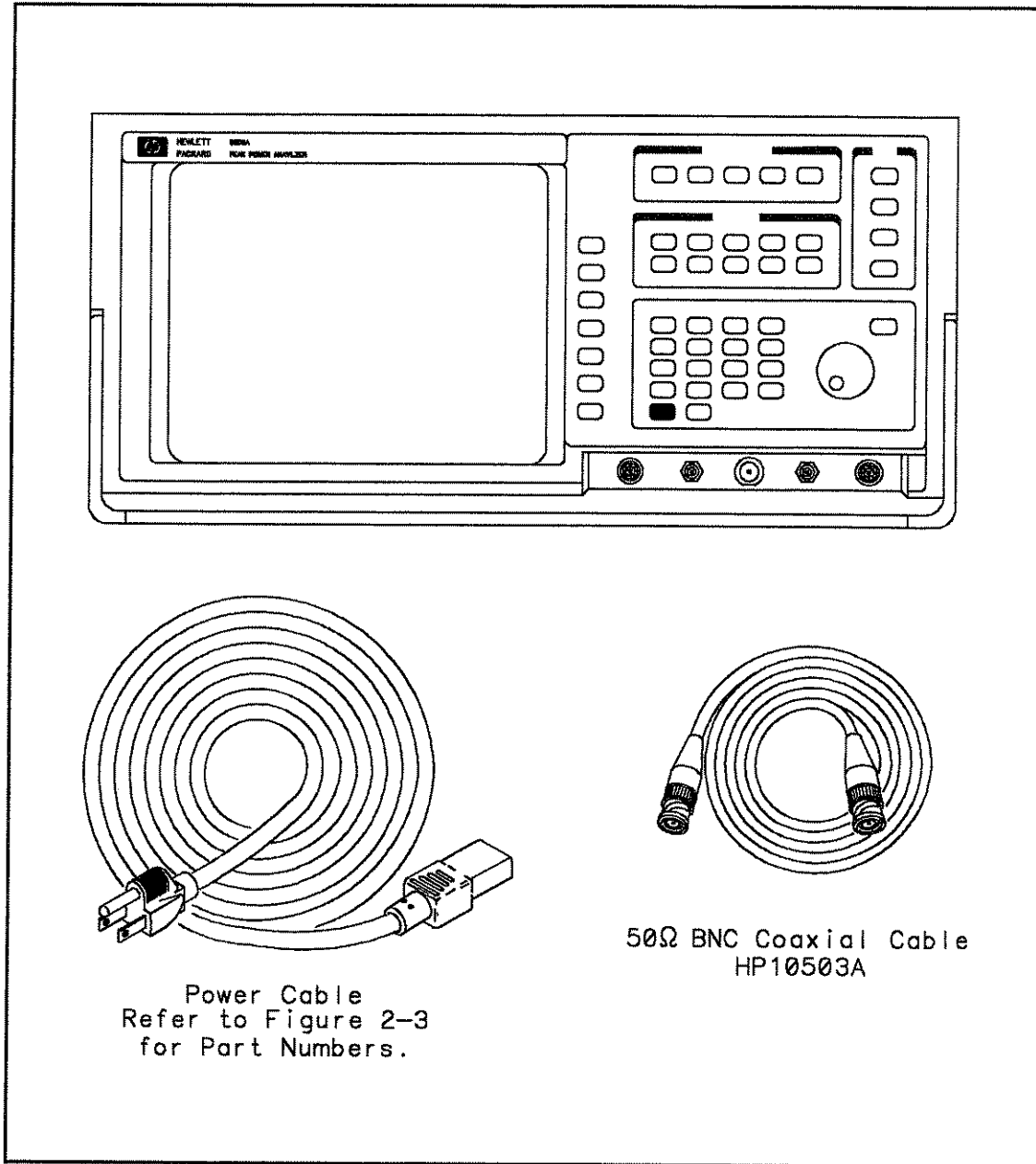

Power Cable  
Refer to Figure 2-3  
for Part Numbers.

50Ω BNC Coaxial Cable  
HP10503A

Figure 1-1. HP 8990A Peak Power Analyzer with Accessories Supplied

**Instruments Covered  
By This Manual**

Attached to the rear panel of the instrument is a serial number identification label. The serial number is in the form: 0000A00000. The first four digits and the letter are the serial number prefix. The last five digits are the suffix. The prefix is the same for identical instruments; it changes only when a configuration change is made to the instrument. The suffix, however, is assigned sequentially and is different for each instrument.

**Manual Change  
Package**

A "Manual Change Package" is shipped with the Peak Power Analyzer when a change has been made to the instrument. The package consists of replacement pages. The package is identified by it's own part number.

**Description**

The Hewlett-Packard Model 8990A Peak Power Analyzer provides complete pulse characterization in the range of 500 MHz to 40 GHz, depending on the peak power sensor used. The Analyzer has a dynamic range of -32 to +20 dBm. It is compatible with the HP 84812A, 84813A, and 84814A line of Peak Power Sensors. All functions are fully programmable.

The Peak Power Analyzer has four channels and is menu driven. Two channels are RF and two are video. Ten functions are available through the menus: timebase, channel selection, triggering, display setup, markers, carrier frequency selection, waveform math, waveform memory, waveform measurement, and utilities.

The RF or video signal can be characterized for the following parameters: peak power, average peak power, risetime, falltime, frequency (Pulse Repetition Rate), pulse period (Pulse Repetition Interval), pulse width, pulse off time, duty cycle, delay, statistically defined pulse top and pulse bottom, overshoot, and average power.

External and internal triggering are available. The two video channels which are used for external triggering

also have limited oscilloscope capabilities. Instrument configurations can be stored and recalled.

## Options

### Electrical Options

**Single Sensor Input (Option 001).** Sensor input, channel four, is deleted.

**Rear Panel Sensor Inputs (Option 002).** Sensor inputs, channels one and four, are deleted from the front panel and placed on the rear panel.

### Miscellaneous Options

**Service Manual (Option 915).** Option 915 is used to add the Service Manual to the initial order for the Peak Power Analyzer. However, if the manual was not ordered initially, it may be ordered separately by calling Hewlett-Packard's Direct Marketing Division at **1-800-538-8787** in the United States and Canada. In Europe, the Service Manual may be obtained by calling your nearest Hewlett-Packard office. The part number of the manual is HP 08990-90004.

**Additional User Documentation (Option 916).** Option 916 is used to add an additional Operating and Programming Manual to the initial order for the Peak Power Analyzer. Included with the Operating Manual is the Getting Started Guide and a disk which is used for the Instrumentation Uncertainty Performance Test. However, additional manuals may be ordered by calling Hewlett-Packard's Direct Marketing Division at **1-800-538-8787** in the United States and Canada. In Europe, the manuals may be obtained by calling your nearest Hewlett-Packard office. The part number of the Operating Manual (including Getting Started Guide and disk) is HP 08990-60037. Refer to the following paragraph for the part number of the Programming Manual.

**Additional Programming Manual or Getting Started Guide.** Additional copies of the Programming Manual or Getting Started Guide may be ordered by calling Hewlett-Packard's Direct Marketing Division at **1-800-538-8787** in the United States and Canada. In Europe, the manuals may be obtained by calling your nearest Hewlett-Packard office. The part numbers of the manuals are as follows: Getting Started Guide, 08990-90003 and Programming Manual, 08990-90002.

**Accessories Supplied**

The accessories supplied with the Peak Power Analyzer are listed below and shown in figure 1-1.

- Power Cable, (Refer to figure 2-3, Power Cable and Line (Mains) Plug Part Numbers for the part number of your power cable.)
- 50  $\Omega$  BNC Coaxial Cable, HP Part Number 10503A

**Accessories Available**

**Electrical**

**30 dB Attenuator.** This is a 25 Watt, 30 dB fixed attenuator with a frequency range of DC to 18 GHz. This attenuator allows peak power measurements to 25 Watts. The part number of the attenuator is HP 8498A Option 030.

**APC-3.5 mm Adapter.** This is an APC-3.5 mm (female) to Type-N (male) adapter. The adapter is needed to connect the HP 84813A Peak Power Sensor to the Sensor Check Source. The part number of the adapter is HP 1250-1744.

**2.4 mm Adapter.** This is a 2.4 mm (female) to Type-N (male) adapter. The adapter is needed to connect the HP 84814A Peak Power Sensor to the Sensor Check Source. The part number of the adapter is HP 11903D.



**Mechanical**

**Rack Mount Assembly.** The Rack Mount Assembly Kit provides the necessary hardware to mount the Analyzer in a standard nineteen inch rack. The kit includes a front panel power switch and four BNC inputs to deliver signals from the Peak Power Analyzer's front panel (or rear panel) to the rear (or front) of the rack mount assembly. The assembly height is 8-3/4 inches. The part number of the assembly is HP 5061-6175.

**Recommended Test Equipment**

Table 1-3 lists the test equipment recommended for use in testing, adjusting and servicing the HP 8990A Peak Power Analyzer. The Critical Specifications column describes the essential requirements for each piece of test equipment. Other equipment may be substituted if it meets or exceeds these critical specifications.

The Recommended Model column may suggest more than one model. The first model shown is usually the least expensive, single purpose model. Alternate models are suggested for additional features that would make them a better choice in some applications.

**Table 1-1. Specifications**

Warranted specifications are shown in normal typeface. Supplemental characteristics are indicated with italics. Supplemental characteristics provide “typical” or “nominal” performance parameters that are non-warranted but are useful for estimating capability.

**Warranted specifications are guaranteed after the Peak Power Analyzer has had a one hour warm-up period.**

**Sensor Inputs (Channels 1 & 4)**

**FREQUENCY RANGE:**

0.5 to 18 GHz	With sensor HP 84812A
0.5 to 26.5 GHz	With sensor HP 84813A
0.5 to 40 GHz	With sensor HP 84814A
0.05 to 18 GHz	With sensor HP 84815A

**POWER MEASUREMENT RANGE:  $-32^1$  to  $+20$  dBm**

**RISETIME<sup>2</sup>/FALLTIME<sup>2</sup> (10-90%/90-10%):**

Input Signal <sup>3</sup>	Risetime/Falltime	<i>Video Bandwidth<sup>2</sup> (Typical)</i>
0 to $+20$ dBm	$< 5$ ns <sup>4</sup>	<i>150 MHz<sup>5</sup></i>
$-16$ to 0 dBm	$< 6$ ns <sup>4</sup>	<i>150 MHz<sup>5</sup></i>
$-26$ to $-16$ dBm	$< 1$ $\mu$ s	<i>500 kHz</i>
$-32$ to $-26$ dBm	$< 80$ $\mu$ s	<i>8 kHz</i>
<i><math>-40</math> to <math>-32</math> dBm</i>	<i><math>&lt; 250</math> <math>\mu</math>s (Typical)</i>	<i>2.5 kHz</i>

1 Usable down to  $-40$  dBm.

2 With the Channel Menu bandwidth key set to HIGH.

3 With a displayed signal height  $\geq 2$  divisions.

4 The optional 20 foot long peak power sensor cable degrades the specified risetime to 10 ns. Specification for the HP 84815A is  $< 45$  ns.

5 Single shot bandwidth is limited to 1 MHz. Single shot bandwidth is based on 10 points per pulse. In single shot mode, the 10 MHz sampling rate limits minimum risetime to 100 ns given a time base setting of  $\leq 5$   $\mu$ s/division.

Table 1-1. Specifications (continued)

**Sensor Inputs (Channels 1 & 4) (continued)***PULSE REPETITION RATE, MAXIMUM:**100 MHz                      Externally Triggered**1 MHz                         Internally triggered**MINIMUM PULSE WIDTH: 10 ns**LOG VERTICAL SCALE<sup>1</sup>: 1, 2, 5 dB/division**LINEAR VERTICAL SCALE<sup>1</sup>: 50 nW/division to 20 mW/division in 1-2-5 sequence**INSTRUMENTATION UNCERTAINTY (including noise and offset):<sup>2,3</sup>*

$$\pm(5.5\% + \frac{0.07\mu\text{W}}{\text{Signal Power}} \times 100\%)$$

**Video Inputs (Channels 2 & 3)**

Channels 2 and 3 are limited dynamic range scope inputs, optimized for external triggering using digital signals. Extended range can be achieved by using attenuating probes.

**BANDWIDTH (dc-coupled):**

Repetitive: dc to 100 MHz (–3 dB)

Single Shot: dc to 1 MHz (10 points per pulse)

**BANDWIDTH (ac-coupled):**

Repetitive: 10 Hz to 100 MHz (–3 dB)

Single Shot: 10 Hz to 1 MHz (10 points per pulse)

**RISETIME:** <5 ns**VERTICAL GAIN ACCURACY (DC):** ±1.5%**OFFSET ACCURACY:** ±2% of offset + 0.2 x (V/division)

1 The sensitivities given apply to one screen per display. If two or four screens are displayed, sensitivities decrease by a factor of two or four respectively.

2 With a displayed signal height  $\geq 2$  divisions and using 128 averages.

3 Instrumentation uncertainty is one of the factors that affects overall power measurement accuracy. For a listing of the other factors that affect overall power measurement accuracy and an example of how to calculate it, refer to Table 1-2, Calculating Overall Power Measurement Accuracy.

Table 1-1. Specifications (continued)

<b>Video Inputs (Channels 2 &amp; 3)(continued)</b>	
MAXIMUM INPUT VOLTAGE: $\pm 100$ volts (dc + peak ac < 10 kHz)	
VERTICAL SENSITIVITY: 100 mV/division to 500 mV/division	
AVAILABLE OFFSET RANGE: $\pm 20$ volts	
INPUT IMPEDANCE: 1 M $\Omega$ , 16 pF	
INPUT COUPLING: ac, dc	
<b>Sensor and Video Inputs (Channels 1, 2, 3, and 4)</b>	
MANUAL MARKER RESOLUTION: 0.4% of full scale	
CHANNEL-TO-CHANNEL ISOLATION:	
Channel 2 to Channel 3: 30 dB, dc to 100 MHz	
Channel 2 to Channel 1 and Channel 3 to Channel 4: 40 dB, dc to 100 MHz video bandwidth	
<b>Time Base</b>	
RANGE: 2 ns/division to 5 s/division, in a 1-2-5 sequence.	
ACCURACY: 0.005%	
DELTA t ACCURACY <sup>1</sup> : 1 ns $\pm [(5E-5) \times \text{Delta t}] \pm [0.02 \times (t/\text{div})]$	
DELAY RANGE (post-trigger):	
<i>Time Base</i>	<i>Available Delay</i>
50 ms-5 s	40 x (s/division)
100 $\mu$ s-20 ms	1 s
2 ns-50 $\mu$ s	10,000 x (s/division)

<sup>1</sup> Delta t accuracy for dual-marker, single-channel-measurement, or for channel-to-channel measurement after visual time null calibration has been done.

Table 1-1. Specifications (continued)

<b>Time Base (continued)</b>	
<i>DELAY RANGE (pre-trigger):</i>	
<i>Time Base</i>	<i>Available Delay</i>
10 $\mu$ s–5 s	–40 x (s/division)
20 ns–5 $\mu$ s	–200 $\mu$ s
2 ns–10 ns	–10,000 x (s/division)
<i>TIME BASE RESOLUTION: 100 ps</i>	
<b>Internal Triggering (Channels 1 and 4)<sup>1</sup></b>	
SENSITIVITY:	0.25 x full scale and >–30 dBm
BANDWIDTH: <sup>2</sup>	dc to 1 MHz
<b>External Triggering (Channels 2 and 3)</b>	
SENSITIVITY:	0.2 Vpp, dc–1 MHz
	0.5 Vpp, 1 MHz–100 MHz:
BANDWIDTH: <sup>3</sup>	dc to 100 MHz
<i>TRIGGER PULSE WIDTH, (MINIMUM): 7 ns</i>	

1 Channel 2 or 3 should be used as the triggering channel when timebase settings of less than 10 ns/division are used and accurate timing measurements are required.

2 Equal to video bandwidth when < 1 MHz. Some vertical sensitivities may require lower bandwidth settings.

3 External triggering bandwidth is equal to ac coupling bandwidth or bandwidth limit when chosen on the Channel Menu.

Table 1-1. Specifications (continued)

**Sensor Check Source**

POWER LEVEL<sup>1</sup>: +10 dBm  $\pm$ 0.5 dB

FREQUENCY: 1.05 GHz  $\pm$  (nominal)

SIGNAL TYPE: Square wave modulated (CW selectable)

REPETITION RATE: 1.5 kHz

CONNECTOR: Type-N (female)

SWR (REFLECTION COEFFICIENT): 1.35 (0.15) at 1.05 GHz

**Additional Characteristics:**

MAXIMUM SAMPLE RATE: 10 million samples per second (for time base setting of  $\leq$  5  $\mu$ s/division)

VERTICAL RESOLUTION: 0.4% (8-bit A/D)

MEMORY DEPTH:<sup>2</sup>501 points (display); 1024 points (Over HP-IB)

**Remote Operation (HP-IB)<sup>3</sup>**

IEEE COMPATIBILITY CODE (STD 488.2-1988): SH1, AH1, T5, L4, SR1, RL1, PP1, DC1, DT1, C0, and E2.

DATA ACQUISITION AND TRANSFER RATE: A 500-point data record can be acquired and transferred to a computer at a rate of approximately 10 times per second, as tested with an HP 9000 Series 200 Controller.

DATA TRANSFER RATES: Approximately 120 kbytes/second

1 Specified for a temperature range of 10°C to 40°C.

2 For single-shot over HP-IB, maximum memory depth is 501 points. For  $<$ 5 ns/division time base range, memory depth is 200 points.

3 The Hewlett-Packard Interface Bus (HP-IB) is Hewlett-Packard's implementation of IEEE Std 488-1978, "Digital Interface for Programmable Instrumentation." Most functions are remotely programmable.

Table 1-1. Specifications (continued)

**Rear Panel Connectors**

AC CAL OUTPUT: This is a 1.5 kHz square wave used for probe calibration, and internal frequency and delay adjustments.

DC CAL OUTPUT: This output is used for vertical calibration of the Peak Power Analyzer.

TRIGGER OUTPUT (CHANNEL 1): TTL level signal corresponding to the internal trigger signal of Channel 1.

TRIGGER OUTPUT (CHANNEL 4): TTL level signal corresponding to the internal trigger signal of Channel 4.

**General Characteristics**

EMI: Conducted and radiated interference is within the requirements of CE03, CS01, CS02 of MIL-STD-461C. It is also within the requirements of VDE 0871/1978, Level B and CISPR Publication 11 (1975), with a channel 2 or 3 input level of < 2 volts.

**ACOUSTIC NOISE EMISSION (GERAEUSCHEMISSION):**

LpA <70 dB(A) per ISO 3744 (LpA <70 dB(A) nach DIN 45635 pt. 1)

LpA Operator position ... 42 dB<sup>1</sup> (LpA am Arbeitsplatz... 42 dB<sup>2</sup>)

LpA Bystander position ... 39 dB<sup>1</sup> (LpA fiktiver Arbeitsplatz ... 39 dB<sup>2</sup>)

OPERATING TEMPERATURE: 0 to 55°C

STORAGE TEMPERATURE: -40 to +71°C

LINE VOLTAGE: 90—132 or 198—264 Vac, 48 to 66 Hz

POWER DISSIPATION: 250 VA maximum

1 Based upon type test per ISO 6081.

2 Typprüfungsresultat nach DIN 45635 pt. 19

Table 1-1. Specifications (continued)

<p><b>General Characteristics (continued)</b></p> <p><i>MEASUREMENT SPEED: 3 measurements per second, Manual operation; 3—65 readings per second, over HP-IB, with no display and not including trigger latency.</i></p> <p><b>DIMENSIONS:</b></p> <p><i>Height: 194.3 mm (7.65 in)</i></p> <p><i>Width: 422.3 mm (16.62 in)</i></p> <p><i>Depth: 366.0 mm (14.4 in)</i></p> <p><b>WEIGHT:</b></p> <p><i>Net Weight: 12.8 kg (28 lb)</i></p> <p><i>Shipping Weight: 20.1 kg (44 lb)</i></p>
---



Table 1-2. Calculating Overall Power Measurement Accuracy

Overall Root Sum of the Squares (RSS) power measurement uncertainty is obtained by calculating the RSS of the following individual uncertainties:

**INSTRUMENTATION UNCERTAINTY** (including Noise and Offset)

$$\pm(5.5\% + \frac{0.07\mu\text{W}}{\text{Signal Power}} \times 100\%)$$

**SENSOR CALIBRATION UNCERTAINTY:** Refer to the peak power sensor Operating Manual for the uncertainty figures.

**MISMATCH UNCERTAINTY:**

$$\pm 2 \times \text{Sensor Reflection Coeff} \times \text{DUT Reflection Coeff} \times 100\%$$

Refer to the peak power sensor Operating Manual for the reflection coefficients of the sensors.

**Example**

The source under test has the following characteristics:

Power Output: -10 dBm (100  $\mu\text{W}$ )

Frequency: 14 GHz

Source reflection coefficient

@ 14 GHz: 0.24 (SWR 1.62)

Peak Power Sensor: HP 84812A

Sensor reflection coefficient

@ 14 GHz: 0.11 (SWR 1.25)

Instrumentation Uncertainty, including Noise and Offset:

$$\pm(5.5\% + \frac{0.07\mu\text{W}}{100\mu\text{W}} \times 100\%) = \pm 3.6\%$$

Sensor Cal Uncertainty @

14 GHz: (From HP 84812A sensor manual.) =  $\pm 4.3\%$

Mismatch Uncertainty:  $\pm 2 \times 0.24 \times 0.11 \times 100\% = \pm 5.3\%$

**TOTAL RSS**

**UNCERTAINTY (%)**:  $\pm \sqrt{(3.6\%)^2 + (4.3\%)^2 + (5.3\%)^2} = \pm 7.7\%$

Total RSS Measurement Uncertainty in dB:

$$+7.7\% = 10\log(1+0.077) = 10\log(1.077) = +0.32 \text{ dB}$$

$$-7.7\% = 10\log(1-0.077) = 10\log(0.923) = -0.35 \text{ dB}$$

Table 1-3. Recommended Test Equipment

Equipment	Critical Specifications	Recommended Model	Use <sup>1</sup>
Adapter (BNC to Banana Plug)		HP 1251-2277	P
Adapter (Type N to BNC)		HP 1250-1474	P
Attenuator, Reference	Attenuation: 30 dB	HP 11708A	P
Attenuator	Attenuation: 3 dB Frequency Range: dc to 8 GHz SWR: 1.1	HP 8493C	P
Attenuator, Step	Attenuation: 0-70 dB Step Size: 10 dB	HP 8495G	P
Attenuator	Attenuation: 20 dB Frequency Range: dc to 1 GHz	HP 8491A (Option 020)	P
BNC Tee		HP 1250-0781	P
Cable, BNC		HP 10503A	P
Cable, Sensor	No substitute	HP 84812-60008	P
Controller	≥4 Mbytes RAM HP-IB Interface 3.5 inch dual-sided floppy drive	HP Model 900 series 200/300	
Load, 50 Ω	Frequency: dc to 1 GHz	HP 908A	P
Mixer	Double Balanced IF Port: dc coupled LO & RF Ports: 2 GHz LO Drive: +7 dBm Conversion Loss: < 9 dB, Single Sideband	Watkins Johnson <sup>2</sup> M85C	P
Multimeter	No substitute	HP 3458A	P

1 A= Adjustments, P=Performance, T=Troubleshooting, O=Operational Verification

2 Watkins Johnson, 3333 Hillview Ave., Palo Alto, California 94304-1204

Table 1-3. Recommended Test Equipment (continued)

Equipment	Critical Specifications	Recommended Model	Use <sup>1</sup>
Peak Power Sensor	No substitute	HP 84812A, 84813A, and 84814A	P
Power Meter	Accuracy: 0.02 dB Frequency range: 100 MHz	HP 437B	P
Power Sensor	Power Meter compatible	HP 8482A	P
Power Sensor	Power Meter compatible	HP 8485A	P
Power Sensor	Power Meter compatible	HP 8485D	P
Pulse Generator	Frequency Range: 100 Hz to 1 kHz Sensitivity: 300 mVp-p to 5 Vp-p	HP 8116A	O
Power Supply	Range: 30 mV to 30 V Accuracy: 0.025%	HP 6114A	P
Pulse Generator	Risetime: $\leq 500$ ps	HP 8131A	P
Signal Generator	Harmonics: $\leq 50$ dBc Frequency: 3 GHz Level: -30 to + 20 dBm	HP 83624A	P
Signal Generator	Harmonics: $\leq 50$ dBc Frequency: 3 GHz Level: -30 to + 10 dBm	HP 83620A	P
Signal Generator	Frequency Range: 1 MHz to 2 GHz Accuracy: 0.003%	HP 8657B	P
Switch Driver	No substitute	HP 11713A	P
Universal Source	No substitute	HP 3245A	P

**1-18 This Page Intentionally Left Blank**

## Installation and Operator's Maintenance

---

### Introduction

This section provides the information needed to install and maintain the Peak Power Analyzer. Included is information pertinent to initial inspection, power requirements, line voltage selection, power cables, interconnection, environment, instrument mounting, storage, and shipment. In addition, this section contains the procedures for setting the HP-IB address.

---

### Initial Inspection

#### Warning

---

**To avoid hazardous electrical shock, do not turn on the instrument when there are signs of shipping damage to any portion of the outer enclosure (covers, panels, display).**

---

Inspect the shipping container for damage. If the shipping container or cushioning material is damaged, it should be kept until the contents of the shipment have been checked for completeness, and the Peak Power Analyzer has been checked mechanically and electrically. The contents of the shipment should be as shown in figure 1-1. Procedures for checking electrical performance are given in Section 4. If the contents are incomplete, if there is mechanical damage or defect, or if the Peak Power Analyzer does not pass the electrical performance tests, notify the nearest Hewlett-Packard

office. If the shipping container is damaged, or the cushioning material shows signs of unusual stress, notify the carrier as well as the Hewlett-Packard office. Keep the shipping materials for the carrier's inspection.

---

## Power Requirements

### Warning

**This is a Safety Class I product (that is, it is provided with a protective earth terminal). An uninterruptible safety earth ground must be provided from the main power source to the product input wiring terminals through the power cable or supplied power cable set. Whenever it is likely that the protection has been impaired, the product must be made inoperative and be secured against any unintended operation.**

**If this instrument is to be energized via an external autotransformer, make sure the autotransformer's common terminal is connected to neutral (that is, the grounded side of the line (Mains) supply.)**

---

The Peak Power Analyzer requires a power source of 90–132 Vac or 198–264 Vac, 48 to 66 Hz single phase. Power consumption is 250 VA maximum.

### Note

Although the "Voltage Selection Module" indicates line (mains) voltage ranges of 110–120 Vac and 220–240 Vac, Hewlett-Packard guarantees this product will perform to all specifications over the full line (mains) voltage ranges of 90–132 Vac and 198–264 Vac, 48 to 66 Hz and single phase.

---

## Line Voltage and Fuse Selection

### Caution

Before plugging the Peak Power Analyzer into the line (mains) voltage source, ensure that the correct operating voltage and fuse have been selected.

### Selecting the Line Voltage

The line voltage module has been factory set to the line voltage used in your country. It is a good idea to check the setting of the line voltage module and become familiar with what it looks like. If the setting needs to be changed, do so by the following procedure:

Change the line voltage by pulling the module out and reinserting it with the appropriate arrows aligned.

Carefully pry at the top center of the module (see figure 2-1) until you can grasp and pull it out by hand.

### Checking for the Correct Fuse

If you find it necessary to check or change fuses, remove the module and look at each fuse for its amperage and voltage ratings. Refer to figure 2-2, Checking for the Correct Fuse and Table 2-1, Fuse Rating and Part Numbers.

**Table 2-1. Fuse Ratings and Part Numbers**

Line Voltage	Rating <sup>1</sup>	Part Number
90-132 Vac	2.5A	2110-0083
198-264 Vac	2.5A	2110-0083

<sup>1</sup> Fuses are Time Delay (slow-blow) Fuses.

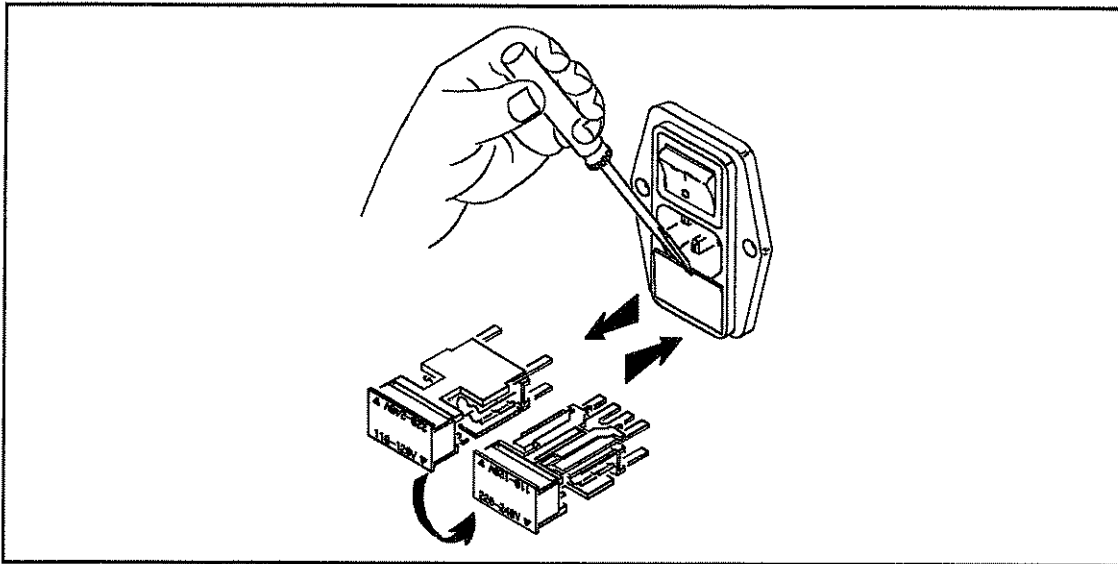

Figure 2-1. Selecting the Line Voltage

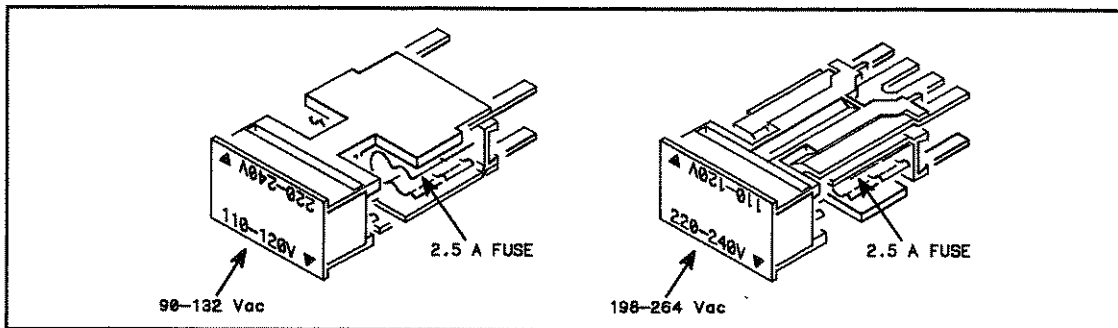

Figure 2-2. Checking for the Correct Fuse



---

## Power Cables

### Warning

---

**BEFORE CONNECTING THIS INSTRUMENT, the protective earth terminals of this instrument must be connected to the protective conductor of the line (Mains) power cable. The line plug shall only be inserted in a socket outlet provided with a protective earth contact. The protective action must not be negated by the use of an extension cord (power cable) without a protective conductor (grounding). Grounding one conductor of a two conductor outlet is not sufficient protection.**

---

The Peak Power Analyzer is shipped with a three-wire power cable. When connected to an appropriate ac power receptacle, this power cable grounds the instrument chassis. The type of power cable plug shipped with each instrument depends on the country of destination. See figure 2-3, Power Cable and Line (Mains) Plug Part Numbers, for the part numbers of these power cables. Cables are available in different lengths and some with right angle plugs to the instrument.

<p>HP 8120-1351 BS 1363A PLUG</p>  <p>UNITED KINGDOM</p>	<p>HP 8120-1369 NZSS 198/AS 3112 PLUG</p>  <p>AUSTRALIA/NEW ZEALAND</p>	<p>HP 8120-1689 CEE 7 STD SHT VII, DIN 49441, VDE 0620</p>  <p>CONTINENTAL EUROPE</p>
<p>HP 8120-1378 NEMA 5-15P</p>  <p>U. S. /CANADA (NOT INTERCHANGEABLE WITH 8120-4753)</p>	<p>HP 8120-1575 IEC 320-C14</p>  <p>SWITZERLAND</p>	<p>HP 8120-2104 SEV 1011.1959-24507 TYPE 12 PLUG</p>  <p>SWITZERLAND</p>
<p>HP 8120-2956 DHCR 107 PLUG</p>  <p>DENMARK</p>	<p>HP 8120-4211 IEC 83, STD 01 (SABS 184)</p>  <p>REPUBLIC OF SOUTH AFRICA and INDIA</p>	<p>HP 8120-4753 MITI 41-9892 PLUG</p>  <p>JAPAN (NOT INTERCHANGEABLE WITH 8120-1378)</p>

Figure 2-3. Power Cable and Line (Mains) Plug Part Numbers

---

## Interconnections

### Hewlett-Packard Interface Bus

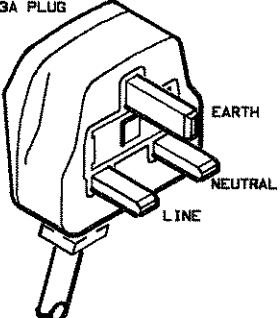
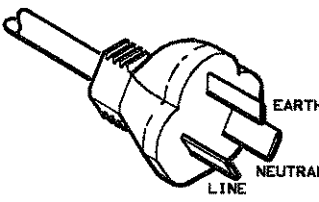
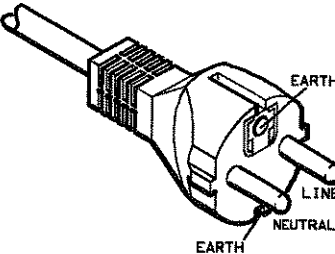
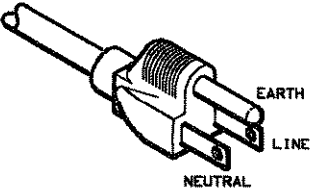
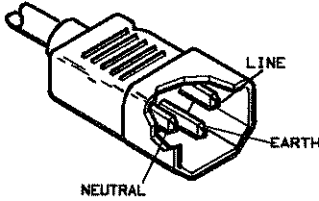
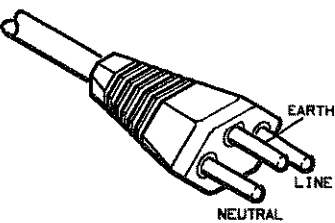
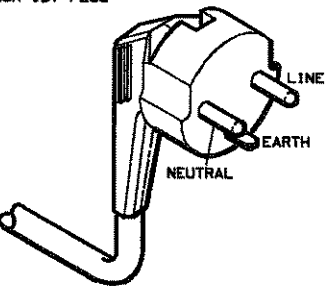
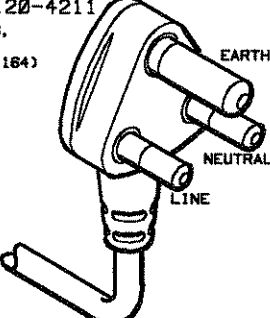
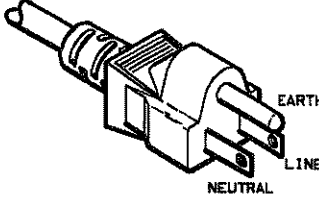
Interconnection data for the Hewlett-Packard Interface Bus is provided in figure 2-4, Hewlett-Packard Interface Bus Connection.

### Peak Power Sensor

The connection from the Peak Power Analyzer to the Peak Power Sensor is made through a cable that is part of the sensor. The sensor cable comes in various lengths. Refer to the peak power sensor manual for more information.

---

## Mating Connectors

### HP-IB Interface Connector.

The HP-IB mating connector is shown in figure 2-4, Hewlett-Packard Interface Bus Connection. Note that the two securing screws are metric.

### Coaxial Connector

This type of connector requires a 50 $\Omega$  BNC male mating connector that is compatible with the specifications of US MIL-C-39012.

**Type N Connector**

This type of connector requires a 50Ω type-N male mating connector that is compatible with the specifications of US MIL-C-39012.

**Peak Power Sensor Input**

This is a special connector that is only compatible with the Hewlett-Packard series of peak power sensors.

---

**Turn-on  
Instructions**

**Warning**

---

**Before the instrument is switched on, all protective earth terminals, extension cords, autotransformers and devices connected to it should be connected to a protective earth grounded socket. Any interruption of the protective earth grounding will cause a potential shock hazard that could result in personal injury.**

**Only 250V slow blow fuses with the required rated current should be used. Do not use repaired fuses or short circuited fuseholders. To do so could cause a shock or fire hazard.**

---

**Note**

---

Before turning the Peak Power Analyzer on, be sure that the "Calibrator" switch on the rear panel is in the **PROTECTED** position.

---

**Turn-On Procedure**

If the Peak Power Analyzer is already plugged in, press the **LINE** switch to **ON (1)**. The **LINE** switch is located on the rear of the Peak Power Analyzer.

If the power cable is not plugged in, follow these instructions.

On the rear panel:

1. Check the line voltage module for correct voltage selection.
2. Check that the fuse rating is appropriate for the line voltage being used. (see figure 2-2). Fuse ratings are printed on the rear panel.
3. Plug in the power cable.
4. On the rear panel, press the LINE switch to ON (1).

**Note**

The Peak Power Analyzer turns on to the same control settings it had before line power was removed. An exception to this is that it always turns on in the local mode. In addition some HP-IB default conditions are enabled.

**Power-up Sequence**

The Peak Power Analyzer goes through the following power-up sequence:

- HP 8990A Peak Power Analyzer and a pulse are displayed for approximately three seconds.

During this period the Peak Power Analyzer tests the non-volatile RAM. Checksums are verified for the calibration data and the previous instrument settings. If a calibration checksum error is detected, an advisory is displayed indicating that a calibration is required:

If the cal RAM is protected, the advisory is "cal ram checksum error, re-cal instrument".

If the cal RAM is unprotected, the advisory is "default cal loaded, re-cal instrument".

In either case, refer to the "instr cal menu" under the Utility Menu. Perform the "vertical cal" and "delay cal" procedures.

If an instrument setting checksum error of non-volatile memory is detected, a recall of default settings is performed automatically.

- The **show** screen is displayed. This screen indicates active channel, trigger, and function information. The menu which was active when the Peak Power Analyzer was turned off has been replaced by the show screen.

---

## **Intensity Control**

Once the Peak Power Analyzer has been turned on, you may want to set the display intensity to a more comfortable setting. Adjust the intensity by turning the DISPLAY INTENSITY control on the rear panel of the Peak Power Analyzer.

---

## **Operator's Checks**

Operator's checks are procedures which are designed to verify proper operation of the Peak Power Analyzer's main functions. The checks consist of two procedures:

- Self Tests
- Front Panel Checks

The self-tests verify that most of the Peak Power Analyzer's circuitry is functioning properly. HP-IB functionality is checked by the HP-IB self-test. The front panel checks assure the user that most front panel features are functioning properly.

**Self-Tests****Note**

---

Before turning the Peak Power Analyzer on, be sure that the "Calibrator" switch on the rear panel is in the **PROTECTED** position.

Running all of the self-tests using the **test all** softkey requires several minutes. Instead of running all self-tests, the individual tests can be run separately.

---

**Procedure**

1. With nothing connected to the Peak Power Analyzer, turn the Peak Power Analyzer on.
2. Push the **UTIL** menu key and observe the Utilities menu on the display.
3. Press **selftest** menu and then **test all**.

If the **selftest** menu key is not displayed, press the **more** key.

As each test is completed, the test name and the results of the test, "PASSED or FAILED" are displayed. The System RAM, Non-volatile RAM, Display RAM, Protected Non-volatile RAM, System ROM, Acquisition RAM, Logic Trigger, Timebase, D/A Converter, HP-IB, and A/D Converter are all tested. If any of the self-tests fail, refer to the Peak Power Analyzer Service Manual.

4. Press the **exit** menu key.
5. Refer to the **instr cal** menu under the **UTILITY** menu to perform the "Vertical Cal" and "Delay Cal" procedures.

## Front Panel Checks

### Equipment

Peak Power Sensor..... HP 84812A, 84813A,  
84814A, or 84815A

### Note

The Peak Power Analyzer requires a one hour warm-up enable to guarantee specified measurement accuracy.

1. Press the **RECALL** key and then the **CLEAR** key.
2. Connect the peak power sensor to Channel 1 and the sensor check source. An adapter may be needed to make the connection.
3. Connect the AC CAL OUTPUT, on the rear panel of the Peak Power Analyzer, to Channel 3.
4. Push the **AUTOSCALE** key. When the message at the top of the display changes from "executing autoscale" to "running", the Peak Power Analyzer displays the power envelope of the pulsed waveform in one window and the trigger signal in the other window.
5. Push the **TIMEBASE** menu key to display the Timebase menu. Turn the knob to change the timebase, and note that the horizontal axis and waveforms are scaled accordingly.
6. Change the timebase so that you display at least one complete pulse segment.
7. Make an automatic peak power measurement of the waveform on channel 1.
  - a. Press the "blue" shift key.
  - b. Select **7** (PEAK) on the keypad.
  - c. Enter "1" when "C#" appears at the bottom of the display.



- d. The measurement result is shown at the bottom of the display. The reading should be  $\approx 10$  mW.
8. Make an automatic average power measurement of channel 1.
  - a. Press the "blue" shift key.
  - b. Select **8** (AVG) on the keypad.
  - c. Enter "1" when "C#" appears at the bottom of the display.
  - d. The measurement result is shown at the bottom of the display. The reading should be  $\approx 5$  mW.
9. Select the **UTIL** key, change the **check source** from pulse to "CW". The displayed waveform and the measurements at the bottom of the display will update accordingly.

The peak power measurement should still read  $\approx 10$  mW. The average power measurement should now be  $\approx 9.91$  mW.
10. Disconnect the channel 3 trigger input.
11. Under the Trigger menu, change the trigger source from channel 3 to channel 1.

This tests the internal trigger mode of the instrument.

The display should not change, and the measured values should be  $\approx 10$  mW.
12. Disconnect the peak power sensor from channel 1 and connect it to channel 4.
13. Connect the AC CAL OUTPUT to Channel 2.

Now channel 4 replaces channel 1 as the RF input for the Sensor Check Source signal. Channel 2 replaces channel 3 as the external trigger input.

14. Repeat steps 1 through 11 in order to verify functionality of channels 2 and 4. When repeating the procedure, be sure to replace any mention of channel 1 with channel 4 and channel 3 with channel 2.
15. If any of the steps of this procedure fail, refer to the Utility Menu section of this manual. Perform the vertical calibration procedure under the "instr cal menu". When the calibration is complete, repeat the checks. If any of the steps fail again, refer to the Peak Power Analyzer Service Manual.

---

## HP-IB Address Selection

The HP-IB address of the Peak Power Analyzer is set using the Utility (UTIL) menu. The Peak Power Analyzer can be placed in "Talk Only Mode" or "Addressed Mode". The following procedure describes how to set the HP-IB address while in "Addressed Mode":

### Note

---

A list of allowable addresses is given in Table 2-2.

---

1. Press the **UTIL** key on the front panel.
2. Press the **HP-IB menu** softkey
3. **talk only**  
Press the **addressed** softkey until addressed is highlighted.
4. Change the address with the knob or the numeric keypad. Valid addresses are 0 through 30. If the keypad is used, select one of the terminators, such as, **s w** or **ms mW** to enter the address.
5. Press **exit menu** to return to the Utility menu.

The Peak Power Analyzer can be set to "Talk Only Mode". This mode is used, for example, when the Peak Power Analyzer outputs data to a printer.

The following procedure describes how to set "Talk Only Mode":

1. Press the **UTIL** key on the front panel.
2. Press the HP-IB menu softkey
3. **talk only**  
Press the **addressed** softkey until "talk only" is highlighted.
4. Press **exit** menu to return to the Utility menu.

**Table 2-2. Allowable HP-IB Address Codes**

Decimal Equivalent <sup>1</sup>	Listen Address Character	Talk Address Character	Decimal Equivalent <sup>1</sup>	Listen Address Character	Talk Address Character
0	SP	@	16	0	P
1	!	A	17	1	Q
2	"	B	18	2	R
3	-	C	19	3	S
4	\$	D	20	4	T
5	%	E	21	5	U
6	&	F	22	6	V
7 <sup>2</sup>	'	G	23	7	W
8	(	H	24	8	X
9	)	I	25	9	Y
10	*	J	26	:	Z
11	+	K	27	;	[
12	,	L	28	<	]
13	-	M	29	=	]
14	.	N	30	>	
15	/	O			

<sup>1</sup> Decimal values are equivalent to the last five bits of both talk and listen addresses.

<sup>2</sup> Decimal 7 is the factory set HP-IB address.

---

**Operating  
Environment**

The operating environment is specified to be within the following limitations:

Temperature	0°C to +55°C
Humidity	<95% relative
Altitude	<4570 metres (15 000 feet)

---

**Bench Operation**

The Peak Power Analyzer has plastic feet and fold-away tilt stands for convenience in bench operation. The plastic feet are designed to ensure self-aligning of instruments when stacked. The tilt stands raise the front of the instrument for easier viewing of the front panel.

---

**Rack Mounting**

Rack mounting information is provided with the rack mounting kit. If the kit was not ordered with the Peak Power Analyzer as an option, it may be ordered through the nearest Hewlett-Packard office. Refer to Mechanical Options in Section 1.

---

## Storage and Shipment

### Environment

The Peak Power Analyzer should be stored in a clean, dry environment. The following environmental limitations apply to both storage and shipment:

Temperature	-40°C TO +71°C
Humidity	<95% relative
Altitude	<15 300 metres (50 000 feet)

### Packaging

**Tagging for Service.** If the Peak Power Analyzer is being returned to Hewlett-Packard for service, please complete one of the blue repair tags located at the end of this manual, and attach it to the instrument.

To minimize repair time, be as specific as possible when describing the failure. Keep the following two items in mind when describing the failure:

1. Describe what makes you think the Peak Power Analyzer is failing.
2. If the failure only occurs under certain conditions, explain how to duplicate the failure.

**Original Packaging.** Containers and materials identical to those used in factory packaging are available through Hewlett-Packard offices. Mark the container "FRAGILE" to encourage careful handling. In any correspondence, refer to the Peak Power Analyzer by model number and full serial number.

**Other Packaging.** The following general instructions should be used for repackaging with commercially available materials.

1. Wrap the instrument in heavy paper or plastic. If shipping to a Hewlett-Packard office or service center, complete one of the blue tags mentioned above, and attach it to the Peak Power Analyzer.
2. Use a strong shipping container. A double-wall carton made of 2.4 MPa(350 psi) test material is adequate.
3. Use enough shock-absorbing material (75 to 100 mm layer; 3 to 4 inches) around all sides of the Peak Power Analyzer to provide a firm cushion and prevent movement in the container. Protect the front panel with an appropriate type of cushioning material to prevent damage during shipment.
4. Seal the shipping container securely.
5. Mark the shipping container "FRAGILE" to encourage careful handling.

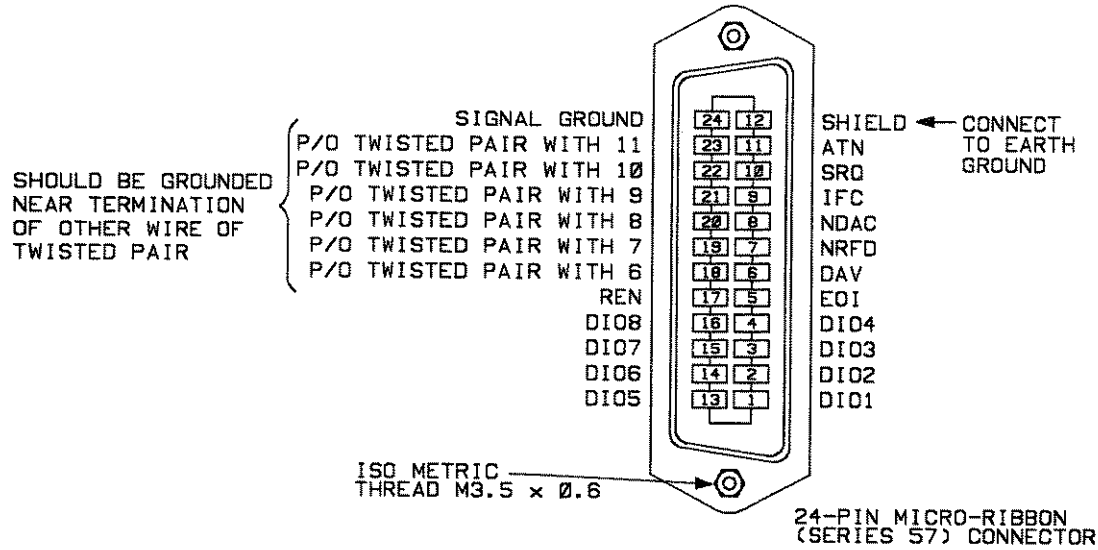

**Logic Levels**

The Hewlett-Packard Interface Bus Logic Levels are TTL compatible, i.e., the true (1) state is 0.0 Vdc to +0.4 Vdc and the false (0) state is +2.5 Vdc to +5.0 Vdc.

**Mating Connector**

HP 1251-0293; Amphenol 57-30240.

**Mating Cables Available**

HP 10833A, 1 metre (3.3 ft), HP 10833B, 2 metres (6.6 ft)  
 HP 10833C, 4 metres (13.2 ft), HP 10833D, 0.5 metre (1.6 ft)

**Cabling Restrictions**

1. A Hewlett-Packard Interface Bus system may contain no more than 2 metres (6.6 ft) of connecting cable per instrument.
2. The maximum accumulative length of connecting cable for any Hewlett-Packard Interface Bus system is 20.0 metres (65.6 ft).

**Figure 2-4. Hewlett-Packard Interface Bus Connection**

---

## Operator's Maintenance Procedures

### Warning

---

**For continued protection against fire hazard, replace the line fuse with a 250V fuse of the same rating only. Do not use repaired fuses or short-circuited fuseholders.**

---

Operator's maintenance consists of replacing defective fuses. The primary power fuse is located within the Line Power Module Assembly. Refer to the section on "Checking for the Correct Fuse" for instructions on how to change the fuse.



## Local Operation

---

### Introduction

This chapter describes the functional sections of the Peak Power Analyzer's front panel. The description of each section also explains its interactions with other sections and provides a basis for applications and usages.

### Turn-on Instructions

#### Warning

---

**Before the instrument is switched on, all protective earth terminals, extension cords, autotransformers and devices connected to it should be connected to a protective earth grounded socket. Any interruption of the protective earth grounding will cause a potential shock hazard that could result in personal injury.**

**Only 250V slow blow fuses with the required rated current should be used. Do not use repaired fuses or short circuited fuseholders. To do so could cause a shock or fire hazard.**

---

#### Note

---

Before turning the Peak Power Analyzer on, be sure that the "Calibrator" switch on the rear panel is in the **PROTECTED** position.

---

**Turn-On Procedure**

If the Peak Power Analyzer is already plugged in, press the LINE switch to ON (1). The LINE switch is located on the rear of the Peak Power Analyzer.

If the power cable is not plugged in, follow these instructions.

On the rear panel:

1. Check the line voltage module for correct voltage selection.
2. Check that the fuse rating is appropriate for the line voltage being used. (see figure 2-2). Fuse ratings are printed on the rear panel.
3. Plug in the power cable.
4. On the rear panel, press the LINE switch to ON (1).

**Note**

---

The Peak Power Analyzer turns on to the same control settings it had before line power was removed. An exception to this is that it always turns on in the local mode. In addition some HP-IB default conditions are enabled.

---

**Power-up Sequence**

The Peak Power Analyzer goes through the following power-up sequence:

- HP 8990A Peak Power Analyzer and a pulse are displayed for approximately three seconds.

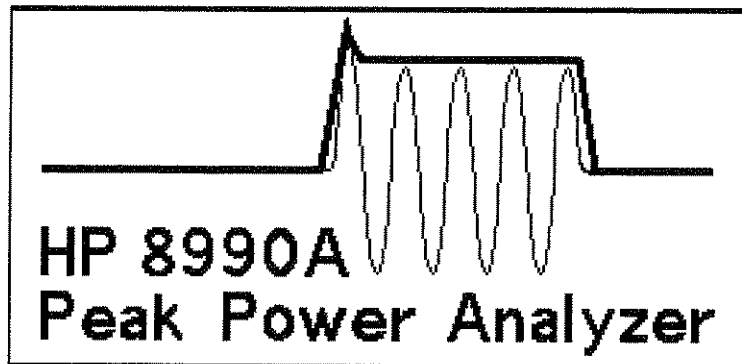

#### Power-Up Display

- During this period the Peak Power Analyzer tests the non-volatile RAM. Checksums are verified for the calibration data and the previous instrument settings. If a calibration checksum error is detected, an advisory is displayed indicating that a calibration is required:

If the cal RAM is protected, the advisory is "cal ram checksum error, re-cal instrument".

If the cal RAM is unprotected, the advisory is "default cal loaded, re-cal instrument".

In either case, refer to the "instr cal menu" under the Utility Menu. Perform the "vertical cal" and "delay cal" procedures.

If an instrument setting checksum error of non-volatile memory is detected, a recall of default settings is performed automatically.

The **show** screen is displayed. This screen indicates active channel, trigger, and function information. The menu which was active when the Peak Power Analyzer was turned off is replaced by the show screen.

---

## Instrument Preset

The Peak Power Analyzer has two methods of instrument preset:

- Key-down power up is a hard preset of the Peak Power Analyzer . It is done by pressing and holding down any front panel key while cycling power. If input signals are not present, the Peak Power Analyzer will power-up displaying a baseline in the SHOW screen and be set to all default settings (see table 3-1).
- RECALL CLEAR performs a soft preset of the Peak Power Analyzer. All default conditions are set (see table 3-1). RECALL CLEAR is the same as a key-down power-up except that the previous menu selections, before RECALL CLEAR was performed, are retained.

Table 3-1. Preset Default Conditions

Timebase Menu	
reference	cntr
Time/Div	100 $\mu$ s
delay	0.00 s
timebase window	off
Channel Menu	
Channel 1	on (With sensor connected.)
Channel 2, 3, and 4	off
Scale	1 mW/Div
external loss	0 dB
Bandwidth	Auto
Volts/Div	500 mV
offset	0.00
coupling	dc
probe attenuation	1.000:1
Trigger Menu	
Mode	edge
triggering	auto
source	Channel 1
level	0.0 W
slope	positive
holdoff	40 ns
Display Menu	
Mode	norm
persistence	minimum
Power Display	linear
off/frame/axes/grid	frame
connect dots	off
# of screens	1

**Table 3-1.**  
**Preset Default Conditions (continued)**

Markers	
Time markers	off
Amplitude markers	off
Carrier Frequency	
ch1=ch4	1 GHz
Waveform Math Menu	
f1	off
f2	off
display	off
chan/mem	chan 1
operator	+
chan/mem	chan 1
function sensitivity	64 mW/Div
function offset	0.0 W
Waveform Memory Menu	
waveform/pixel	waveform
nonvolatile	m1
display	off
source	chan 1

**Table 3-1.**  
**Preset Default Conditions (continued)**

Define Meas Menu	
meas/def/limit	meas
<b>meas</b>	
continuous	on
statistics	off
<b>meas def</b>	
definition	standard
<b>meas limit</b>	
test	off
set	risetime
fail if >	50.0000 s
or if <	1.000 ns
save to	off
after fail	stop
Utility Menu	
<b>HP-IB Menu</b>	
form feed	off
paper length	11 in.
clicker	on
check source	pulse

---

## Instrument Overview

**Front Panel** This section describes the functional sections of the Peak Power Analyzer's front panel. The description of each section also explains its interactions with other sections and provides a basis for applications and usages.

The Peak Power Analyzer has been designed for ease of use. The front panel is separated into six functional areas.

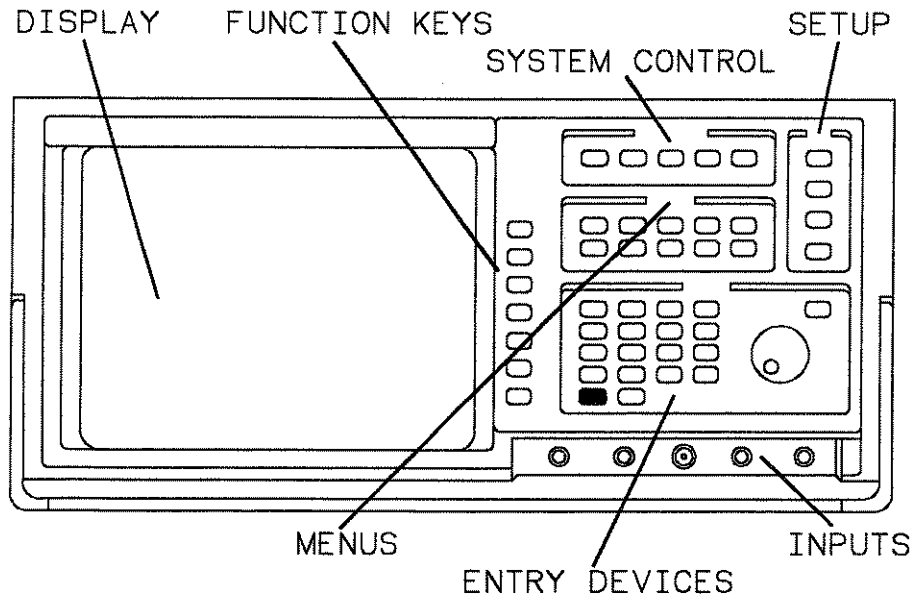

Figure 3-1. HP 8990A Front Panel

### System Control

The System Control keys are located along the top of the Peak Power Analyzer and to the right of the display. This section controls the following functions:

- dynamic display features
- selecting local control
- activating hardcopy



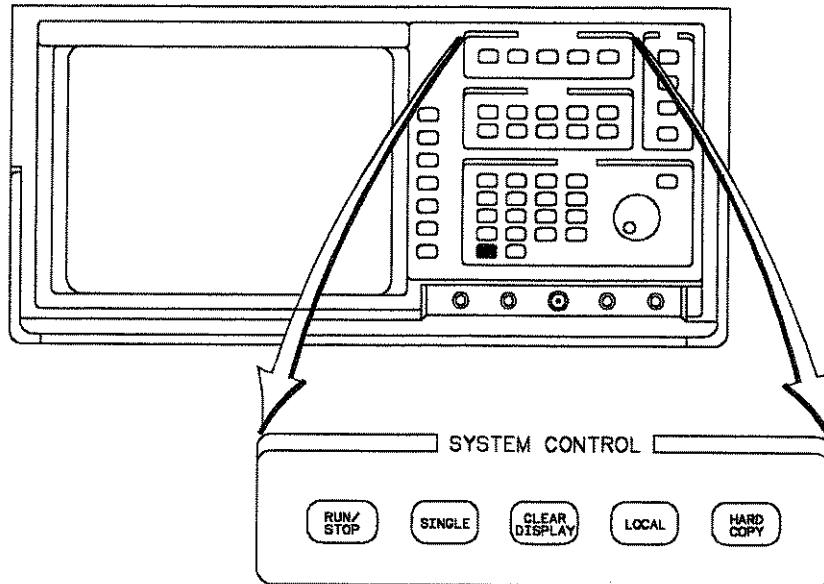

**Figure 3-2. System Control Section**

Selection of any key in the System Control section will cause the Peak Power Analyzer to execute that command immediately.

### **RUN/STOP**

The Run/Stop key toggles the acquisition status of the Peak Power Analyzer. If the Peak Power Analyzer is currently running (current status is displayed in the top left corner of the display in the message field) the instrument is placed in the *stopped* mode. In this mode, acquisition is stopped and the last acquired data is displayed. If the Peak Power Analyzer is started, it is immediately changed to another mode (for example, *running*, *awaiting trigger*, *auto-trigger*, etc).

**SINGLE** The Single key activates the acquisition system for one trigger event. One acquisition is made, displayed and then the data acquisition and display cycle is stopped. This single acquisition is superimposed on the current displayed data. If the display has been cleared before the single key is pressed, only one acquisition is displayed.

**CLEAR DISPLAY** The Clear Display key clears the display and resets all associated measurements. If the Peak Power Analyzer is in the stopped mode, all data that is currently displayed is erased. If the Peak Power Analyzer is *running*, all data is erased; however, new data is displayed on the next acquisition.

The RUN/STOP, SINGLE, and CLEAR DISPLAY keys have a relationship that make it possible to manipulate data acquisitions and view one, two, or several acquisitions. It is possible to stop acquiring, clear the display and capture one acquisition for evaluation. The display can be cleared while acquiring new data. The acquisitions can be manipulated with these three keys while other keys and settings are not affected.

**LOCAL** The Local key sends a return to local control message to the HP-IB interface and returns control to the front panel. This key can be locked out if a local lockout command is executed over HP-IB.

This is the only active front panel key while the Peak Power Analyzer is in remote operation, if it has not been locked out.

**HARDCOPY** This key executes an immediate hardcopy of the currently displayed data to a compatible graphics printer. All other Peak Power Analyzer functions are stopped during printing.

A controller should not be connected to the bus when a hardcopy is requested. The Peak Power Analyzer must

be set to talk only, and the printer must be set to listen only. Setup of the hardcopy options are accessed in the HP-IB submenu (see "Utilities Menu.").

Selection of any key aborts the hardcopy function.

---

## Setup

The Setup section controls subsystems for proper display of data. This section includes the following functions:

- AUTOSCALE for automatic scaling of the waveform display area
- SAVE and RECALL for saving and recalling of instrument setups
- SHOW screen for quick access to channel, function, and trigger information.

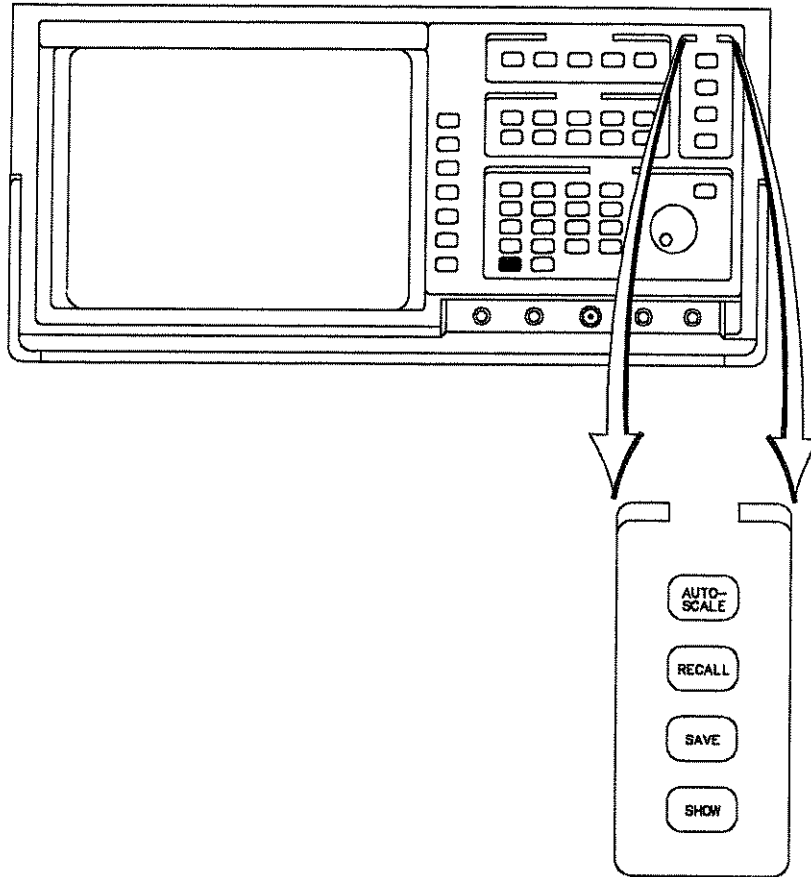

**Figure 3-3. Setup Section**

### **AUTOSCALE**

This key causes the Peak Power Analyzer to evaluate all input signals and set the correct conditions to display the signals. For sensor channels 1 and 4, autoscale is usable on signals in the range of  $-20$  dBm to  $+20$  dBm. It takes from 5 to 30 seconds to find and display the signal(s). Autoscale will run faster when unused sensors are unplugged, and unused channels are turned off. The first autoscale after power-up will run slower than subsequent autoscales.

If signals are present on more than one vertical input, the sweep triggers on channel 2 if a signal is present on that channel. If a signal is not present on channel 2, the Peak Power Analyzer triggers on channel 3 if a signal is present on that channel. If a signal is not present on channel 3, the Peak Power Analyzer triggers on channel 1 if a signal is present on that channel, or on channel 4 if no other signals are found. If no signals are found on any vertical input, the Peak Power Analyzer is returned to its former state.

**Note**

---

Under certain conditions, executing autoscale repeatedly on the same signal may produce a different sweep speed each time.

---

When AUTOSCALE is pressed, the following conditions are set:

- Vertical sensitivity on all channels
- Vertical offset on channels 2 and 3
- Sets trigger to edge mode with minimum persistence, holdoff, positive slope, and proper trigger level for the trigger source
- Sweep speed of displayed channel
- Linear mode display for channels 1 and 4

In addition, Autoscale includes a soft reset:

- Displays the correct number of screens
- Channels without a signal are turned off.
- Turns markers off
- Turns all measurements off
- Turns measurement limit test off
- Turns waveform math functions off
- Turns timebase window off

- Turns waveform/pixel memory display off

The previous Peak Power Analyzer settings are stored in volatile memory, RECALL 0. To recall settings, press RECALL 0.

**RECALL**

The RECALL key has three primary functions:

- By pressing the RECALL key and then selecting 1, 2, 3, or 4, the Peak Power Analyzer executes a recall of a previously saved setup configuration.
- The Peak Power Analyzer automatically saves the current configuration before executing an autoscale, recall, or setting up ECL/TTL presets. RECALL 0 is an undo of these actions. You cannot save to register 0.
- RECALL CLEAR executes an instrument reset and returns the Peak Power Analyzer to default/power-up settings. The Peak Power Analyzer does not perform power-up self-tests (see Instrument Reset).

**SAVE**

The SAVE key immediately stores the Peak Power Analyzer setup configuration in non-volatile memory. Press SAVE, and then select a save register: 1, 2, 3, or 4. An advisory is displayed above the waveform display area indicating the setup configuration has been saved.

**SHOW**

The SHOW key accesses the following information:

- Channel scaling
- Channel offset (Channels 2 and 3)
- Channel coupling (Channels 2 and 3)
- Probe attenuation (Channels 2 and 3)
- Trigger source
- Trigger level

- Math function operation
- Math function scaling
- Math function offset
- Memories

Pressing the SHOW key toggles between the currently selected menu and the SHOW screen (as illustrated).

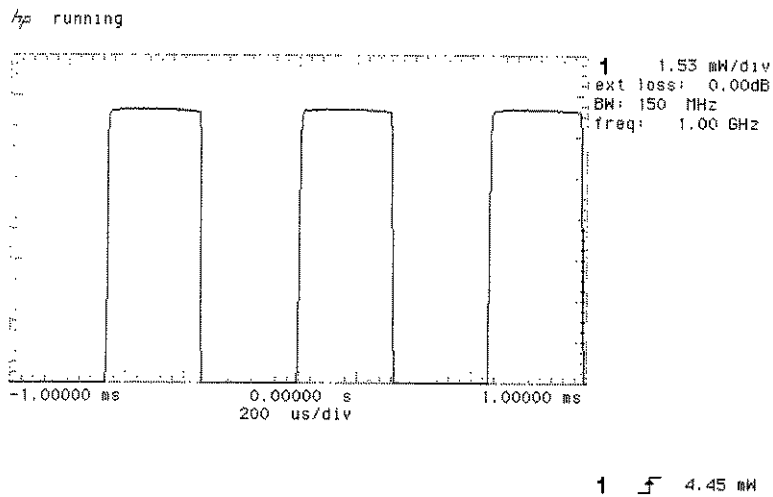

**Figure 3-4. Show Key**

This screen presents the most complete and detailed instrument setup information. Select this screen before making a hardcopy, and all SHOW screen information is included on your hardcopy.

### Entry

The Entry device section contains a multi-function numeric keypad, a selection knob, and a fine key.

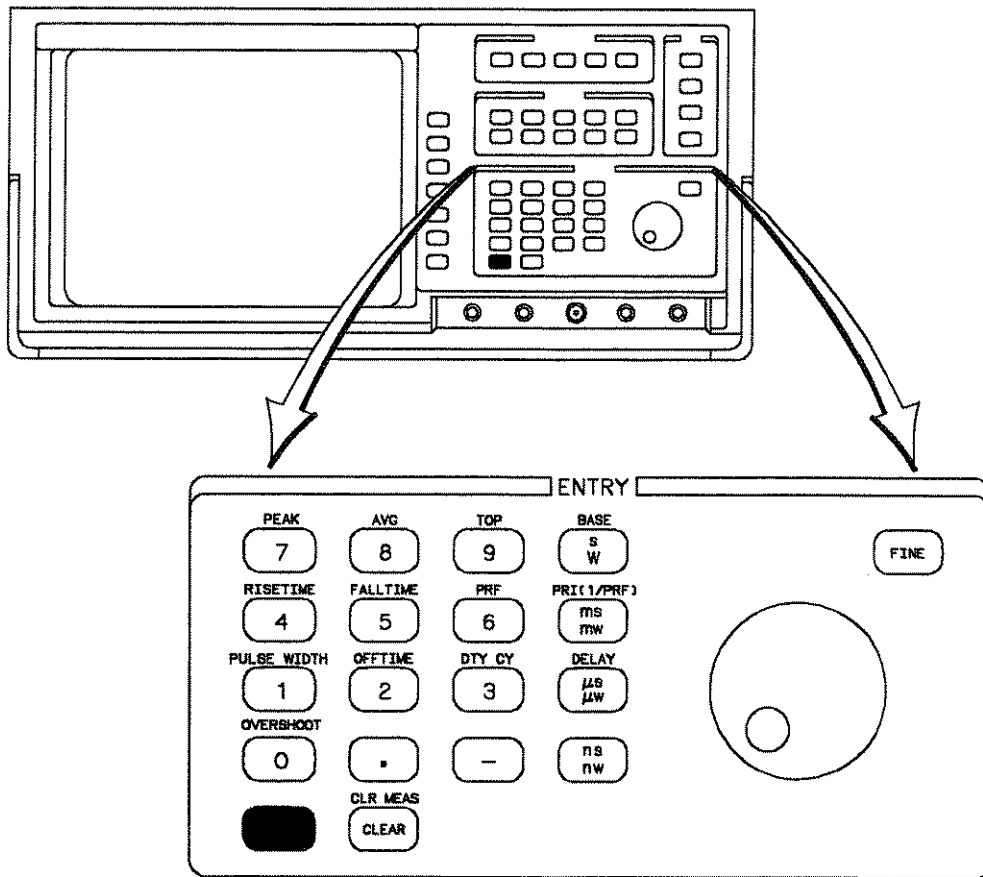

Figure 3-5. Entry Section



**Numeric Keypad**

The keys on the numeric keypad are for direct numeric input. To input known values directly, press the associated softkey to activate the desired field on screen, and then select the units with the numeric keys. For example, to set the vertical sensitivity to 10 mW/division:

- Ensure mW/division on the Channel 1 and 4 menu is the active field (displayed in fullbright)
- Press **1, 0, mW** on the numeric keypad.

The blue shift key selects the alternate function of a key. The CLEAR key clears a numeric entry before a terminator is selected.

**KNOB**

The KNOB changes values within each function. It increments, decrements, or toggles the selection in the active field or function. The current selection is shown in fullbright.

**FINE**

The FINE key changes the increment and decrement step size. Instead of changing in the normal sequence, the values increment/decrement in more precise values. Use this feature when the normal sequence is too coarse for precision measurements or settings. Not all parameters are affected by the FINE key. This key toggles on and off.

When the Peak Power Analyzer is operating in the fine mode, the word *fine* is displayed in the lower right corner of the display.

---

**Input**

The input section consists of connectors for signal input. Channels 2 and 3 have a nominal 1 M $\Omega$  input impedance shunted by approximately 16 pF at the input BNC and a maximum tolerance of 100 V. The peak power sensors are connected to channels 1 and 4. For more information, refer to the Operating and Service manual for the peak power sensor.

---

**Sensor Check Source**

A 1 GHz signal at a level of +10 dBm  $\pm$ 0.5 dB is available at the Sensor Check Source output. The Sensor Check Source can be set to either off, CW, or pulse. When set to pulse, the signal is pulsed at a 1.5 kHz rate. The Sensor Check Source is controlled through the Utility Menu. At power-up or preset, the Sensor Check Source defaults to pulse.

---

**Display**

The Display section contains the screen and menu softkeys.

The vertical column on the right side of the screen is the function display. The functions that are displayed at any one time will correspond to a softkey. The softkeys select any function or field that is displayed in halfbright.

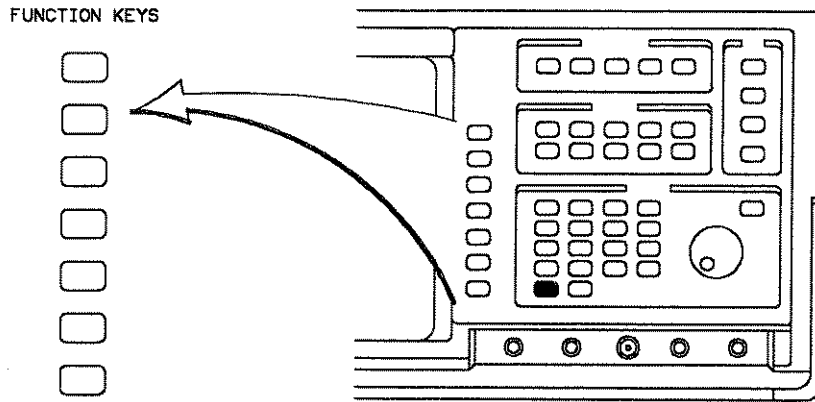

**Figure 3-6. Function Keys**

- Numeric key fields displayed in fullbright are changed by the numeric keys or the knob. When these functions are not active, they are displayed in halfbright; when the functions are displayed in fullbright, they are active.
- Non-numeric fields displayed in halfbright toggle with the corresponding softkey. These fields are displayed in halfbright, but are active for the softkey.

---

## Menus

The Menus section consists of ten keys:

- Timebase
- Channel/Vertical
- Trigger
- Display
- Markers
- Carrier Frequency

- Waveform Math
- Waveform Memory
- Define Measure
- Utilities

Each of these menus is discussed in the following chapters.

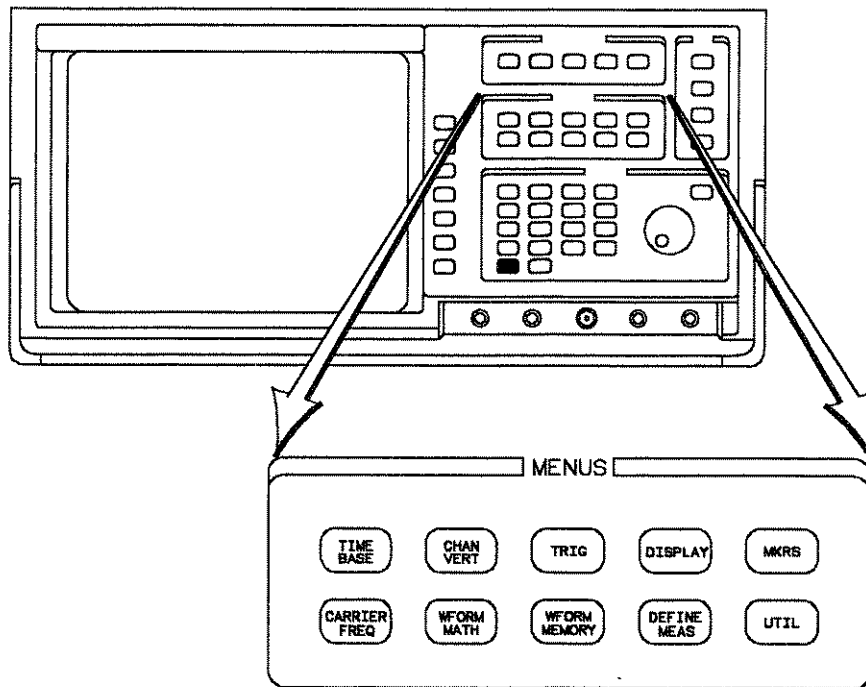
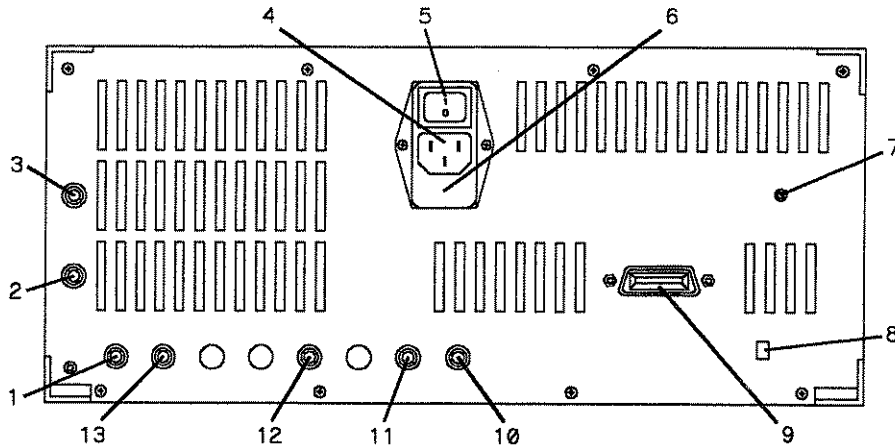
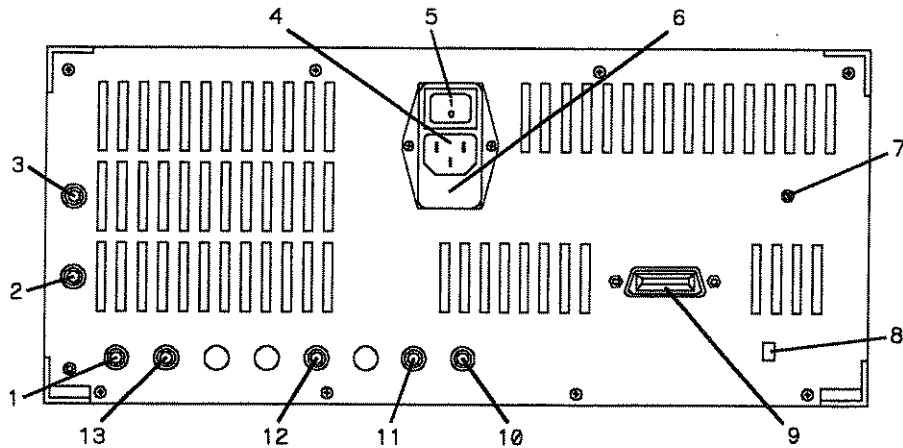

Figure 3-7. Menu Section



**Figure 3-8. Rear Panel Features**

1. **Chassis Ground** In some industrial environments an excessive 60 Hz ground current may flow between the Peak Power Analyzer and the device under test. The current is due to voltage drops between the grounds where the Peak Power Analyzer and the device under test are plugged in. Under extreme conditions, some 60 Hz interference may appear on the display. This effect can be alleviated by powering the Peak Power Analyzer and the device under test from the same outlet, or by using this connector to connect the two chassis together with a short piece of very stout wire or braid.
2. **Channel 1 Sensor Input** This is Option 002. The channel one sensor input is deleted from the front panel and placed on the rear panel.
3. **Channel 4 Sensor Input** This is Option 002. The channel four sensor input is deleted from the front panel and placed on the rear panel.
4. **Power Cable Connection** The supplied power cable is connected to the Peak Power Analyzer at this point.



**Figure 3-8. Rear Panel Features (continued)**

5. **Line switch** This switch is used to turn the Peak Power Analyzer on and off.
6. **Line module** The line module contains the line fuse and is used to match the power transformer to the available line voltage.
7. **Intensity** This is used to adjust the intensity of the display.
8. **Calibrator Switch** This switch controls whether or not the calibration factors in non-volatile RAM will be over written. In the "PROTECTED" position, the vertical calibration and delay calibration factors won't be over written. In the "UNPROTECTED" position, the calibration factors will be over written. Refer to the "instr cal menu" section of the Utility Menu for additional information.
9. **Hewlett-Packard Interface Bus (HP-IB)** Connection to a computer for remote operation is made at this point.

10. **AC Cal Output** This output is a 1.5 kHz square wave used for probe calibration, and internal frequency and delay adjustments. The signal is phased locked to the front panel sensor check source.
11. **DC Cal Output** This output is a DC signal used for vertical calibration.
12. **Trigger Channel 1 Output** This output is a TTL level signal corresponding to the unprocessed edge trigger signal of channel 1. When the Peak Power Analyzer performs a sensor chopping, this signal is turned off momentarily. The chopping may be performed as often as once every three seconds at maximum sensitivity.
13. **Trigger Channel 4 Output** This output is a TTL level signal corresponding to the unprocessed edge trigger signal of channel 4. When the Peak Power Analyzer performs a sensor chopping, this signal is turned off momentarily. The chopping may be performed as often as once every three seconds at maximum sensitivity.

**3-24 This Page Intentionally Left Blank**



## Timebase Menu

### Introduction to the Timebase

This chapter contains a complete description of how the Timebase menu works and controls the entire horizontal display and its parameters. Each function key is described in detail.

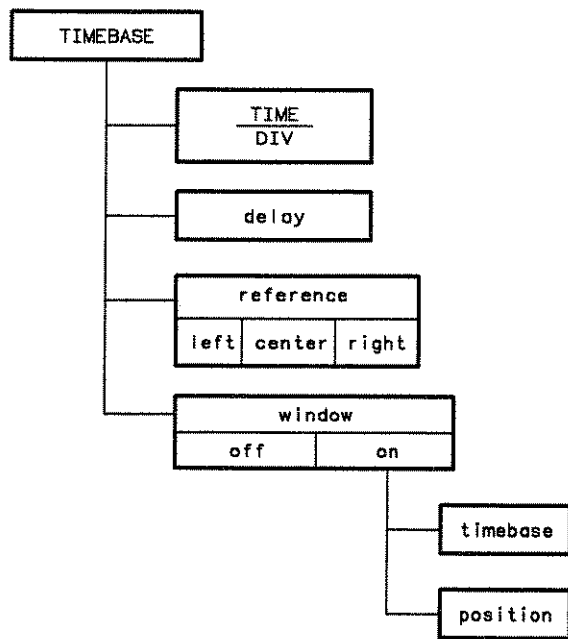

54501/BL01

Figure 3-9. Timebase Menu

---

## Time/Div Key

The time/division function controls the sweep speed on the horizontal axis from 2 ns/div to 5 sec/div. The horizontal axis is ten divisions wide. The main timebase is incremented and decremented in a 1-2-5 sequence. The FINE Key has no affect on the timebase settings.

### Note

---

To display the on or off time of a narrow pulse, the pulse width should not be less than the time per division divided by ten.

---

During slow sweep speeds (200 ms/div to 5 sec/div) the acquisition and write cycle changes. At these sweep speeds the Peak Power Analyzer needs up to 2.5 seconds to generate a trigger and acquisition. Therefore, the displayed data is updated for each data sample.

Scroll trigger mode is available with slow sweep speeds. The Peak Power Analyzer offers one of two scroll trigger modes for acquisition and display:

- *auto triggered scroll* is used in auto trigger. The Peak Power Analyzer acquires and displays data in the auto triggered scroll mode. Each data sample is displayed as it is acquired. As it samples and displays, a message is displayed in the top left corner of the display indicating this acquisition mode.
- *triggered scroll* is used when in trig'd mode and scrolled acquisition is required. Triggered scroll acquisitions are not displayed until all data is available (similar to normal acquisitions) for display. As data is being sampled, the advisory **n s to initialize** is displayed while pre-trigger data is collected and **n s to complete** is displayed while post-trigger data is collected. This message indicates the time needed to complete acquisition, where n is the remaining time (in seconds, s). Countdown continues until the time has elapsed. The advisory *running* is displayed as the

write cycle to the screen is executed and displayed data is updated.

If the reference point (see the reference key description) is set to left, the only advisory displayed is **ns to complete**, because all data is post-trigger. When right reference is set, all data is pre-trigger and the advisory is **ns to initialize**.

Both the keypad and knob can be used to change the sweep speed.

---

## delay Key

Selection of the delay function assigns delay as the active function. When delay is set to 0, the trigger event occurs at the delay reference point. A positive delay allows viewing the waveform after the trigger event, and a negative delay allows viewing the waveform before the trigger event. Therefore, a delay setting of  $-50$  ns indicates that the trigger event occurs 50 ns after the delay reference point.

reference = trigger event + delay

---

## reference Key

The reference key changes the delay reference point to one of three possible settings:

- left
- cntr (center)
- right

These correspond to the left, center, and right portions of the display. If delay is set to 0, the reference point consists of pre-trigger data to the left and post-trigger data to the right.

---

## Window Key

The window function turns on an expanded timebase, and the Peak Power Analyzer is placed in a multiple screen mode. The original waveform and its timebase setting are displayed in the top screen with markers, vertical dotted lines, that enclose a portion of the waveform. The enclosed portion of the waveform is displayed in the bottom screen.

### Note

---

The displayed timebase information under the waveform display area is windowed timebase information. When the window is on, all measurement results and information are windowed information.

If the display has more windows than are desired, it may be that additional windows have been enabled with the **Display Menu** or the **Wform Math Menu**. Select these menus to turn off the undesired windows.

---

This feature is much the same as the delayed sweep on an analog oscilloscope. However, with the dual screen, a portion of the original waveform can be viewed.

The timebase of the windowed waveform can be varied from the same as the normal timebase to 1/20 of the normal timebase. This equates to 1/2 of a major division.

When the reference position is set to left, only the right window marker moves when the window timebase is changed. When the reference is set to right, only the left marker moves, and when center is selected, both markers move. This maintains a specified time reference without changing any timebase settings.

When the window function is enabled, two selections are available for placing and sizing the window:

- Window timebase
- Window position

**timebase Key** This key is activated only when the window function is turned on. It enables the setting of the window timebase.

As the window timebase is increased, the time in the window displayed at the bottom of the screen is increased, and the markers in the top screen begin to move farther apart. When the window reaches full screen, the main timebase and the window timebase become equal. At this point, turning the knob anymore has no affect. As the window timebase is decreased, the markers in the top screen move closer together.

**position Key** This key is activated only when the window function is turned on.

The window can be placed anywhere on the normal waveform. By adjusting the window position, you can see any part of the waveform.

**Window example** The following example uses the Sensor Check Source to demonstrate how to use the window feature.

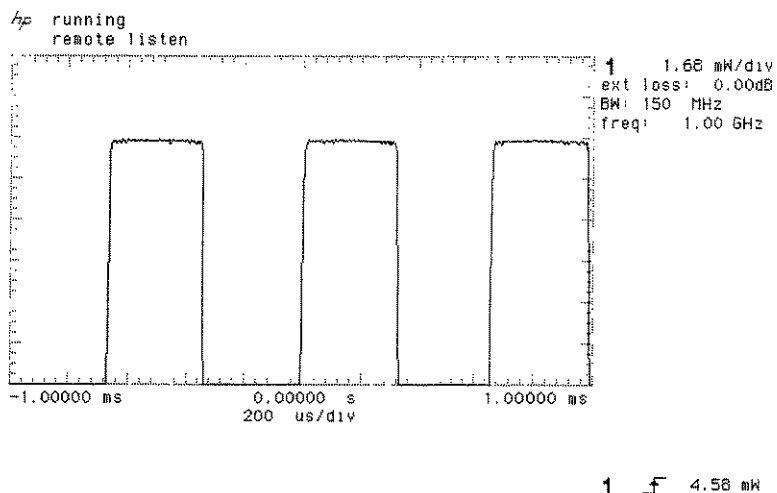

Figure 3-10. Input Signal for Window Viewing

#### Setting the Peak Power Analyzer

- Connect a peak power sensor to the Sensor Check Source and channel 1

#### Note

Adapters (HP 1250-1744, for the HP 84813A Peak Power Sensor and HP 11903D, for the HP 84814A Peak Power Sensor) will be needed. These adapters are not supplied with the Analyzer.

- Disconnect the inputs to any other channels.
- Press **RECALL** and **CLEAR**. There is approximately a five second delay while the preset function is being performed.
- Press the **DISPLAY** menu key.  
Press **connect dots** until **on** is highlighted.
- Press **AUTOSCALE**.
- Press the **TIMEBASE** menu key.

- Press the window key until on is highlighted.
- Set the window timebase to 50  $\mu$ s/div.

Press the timebase key.

Press 5, 0,  $\mu$ s on the keypad.

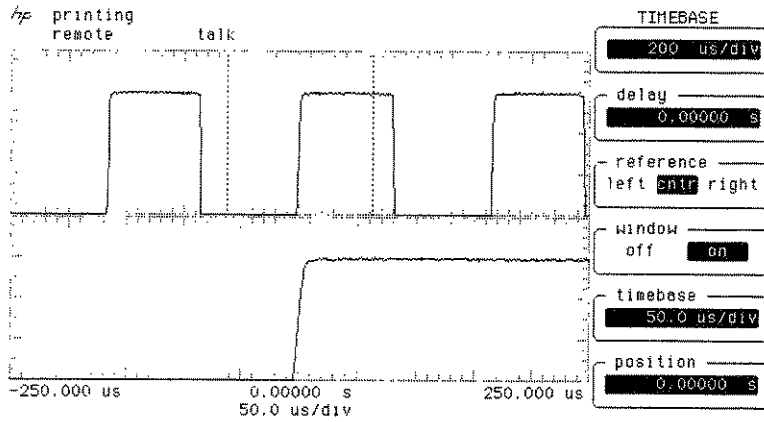

Figure 3-11. Input Signal with Window Turned on

**Note**

The timebase factors under the waveform display area have changed to reflect the window.

**Viewing the Window**

The timebase width in the window is 50  $\mu$ s/division with the trigger point at center reference and zero time delay.

The knob performs the following actions when a field is active (highlighted):

- time/division field (top)—the knob changes both timebases. The displayed waveforms change until the window timebase equals the normal timebase.

- delay—the knob moves the window and waveform sideways while maintaining the same size. This allows viewing of the same section of the waveform at a different point in time. The two timebases will not change.
- window timebase—the knob changes only the window timebase. The range is from 1/20 of the normal timebase to equal to the normal timebase.
- window position—as you turn the knob, the window changes position on the normal waveform allowing you to view different sections of the waveform.



## **Channel Menu**

---

### **Introduction to Channels**

The channel menu controls the vertical operation of the Peak Power Analyzer. This chapter describes the use of the four channels, including vertical scaling and bandwidth selection, for channels 1 and 4 and vertical sensitivity, offset, coupling, attenuation and preset levels, for channels 2 and 3.

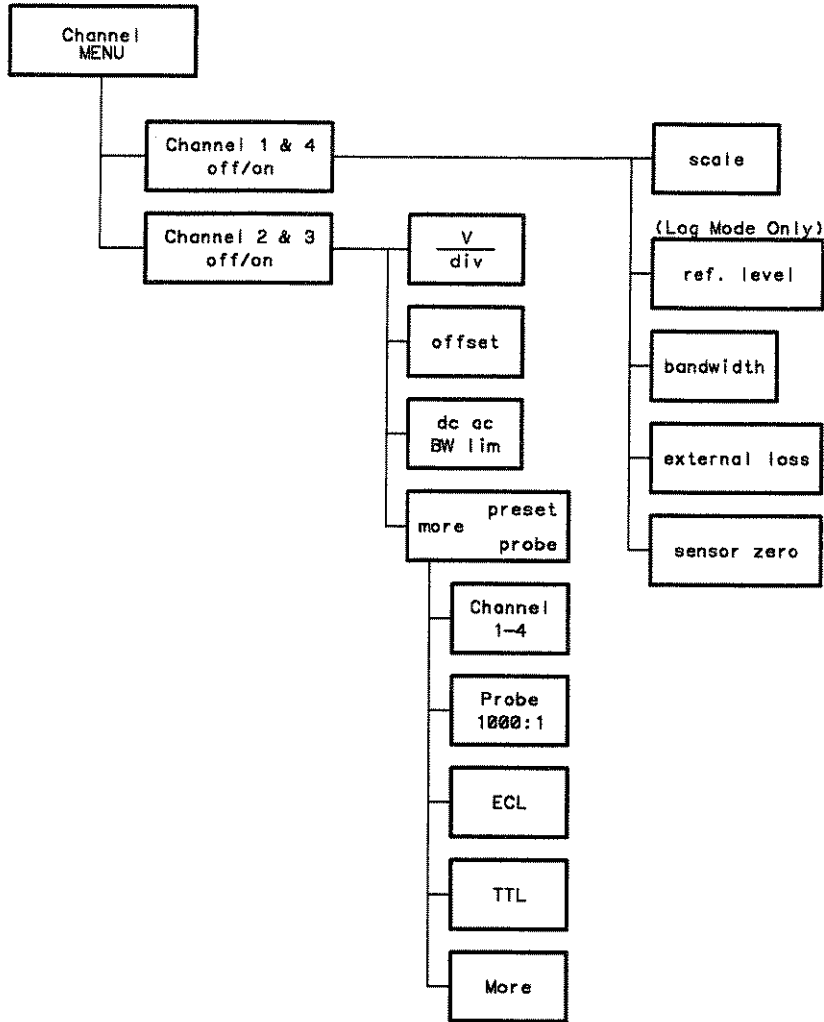

Figure 3-12. HP 8990A Channel Menu

---

## Channel Key

The top key in the channel menu is for channel selection. The key toggles through channels one through four. When a channel is selected (highlighted in inverse video) it can then be turned on with the next key. When a channel is turned on, the small circle immediately below the channel number is highlighted.

### Note

It is possible to have a channel turned on and be viewing it while in the vertical control menu of another channel. When making changes, ensure you have the proper channel and function selected, and be sure you are changing the channel you intend to change.

When Option 001, Single Sensor Input, is installed, channel 4 is not useable. If an attempt is made to turn channel 4 on, the advisory "no Baseband assembly found cannot turn on channel" is displayed.

---

---

## Channels 1 and 4

### Vertical scale key

The current power per division is displayed with the current units selection. The units per division (dBm or watts) is selected with the display menu. When this function is selected, either of the entry devices can be used for data entry.

The range for vertical scaling is 50 nW/division to 20 mW/division, in linear mode and 1 dB/division to 5 dB/division, in log mode. Loss entered with the external loss key will affect the vertical sensitivity. When the knob is used, vertical sensitivity changes in a 1-2-5 sequence in linear and log mode. The FINE key will affect scaling in linear mode.

**reference level Key**  
*(log mode only)*

This key is used to set the reference level at the top line of the display.

When this function is selected, either of the entry devices can be used for data entry. Allowable levels are affected by the linear units per division setting and the external loss setting. The FINE key can be used during reference level selection.

**Bandwidth Key**

Noise may be visible on the detected signal from the peak power sensor. The bandwidth key is used to minimize the affect of the noise. This key selects the available bandwidth of an internal low pass filter. The maximum bandwidth available is 150 MHz. There are two variable parameters which determine the bandwidth:

- Vertical sensitivity
- Under rare conditions, the temperature at the peak power sensor will affect internal amplifier selection.

This field has three possible selections. A selection is made by pressing the softkey until the desired area is highlighted:

- **Auto** When auto is selected, the Peak Power Analyzer selects the optimum level between available bandwidth and noise.
- **Low** When low is selected, the bandwidth is the lowest possible with the selected vertical sensitivity.
- **High** When high is selected, the bandwidth is the highest possible with the selected vertical sensitivity.

The following table lists representative performance for the three possible settings. Bandwidth switching points are dependant upon circuit gain as well as ambient temperature. Bandwidth may differ somewhat from unit to unit and over wide temperature swings.

## Bandwidth Settings

Vertical Sensitivity (per division)	Auto	Low	High
20 mW to 20 $\mu$ W	150 MHz	12 MHz	150 MHz
10 $\mu$ W	12 MHz	25 kHz	150 MHz
5 $\mu$ W	500 kHz	25 kHz	500 kHz
2 $\mu$ W	8 kHz	600 Hz	500 kHz
1 $\mu$ W	8 kHz	600 Hz	500 kHz
500 nW	8 kHz	600 Hz	8 kHz
200 nW	2.5 kHz	600 Hz	8 kHz
100 nW	600 Hz	600 Hz	2.5 kHz
50 nW	600 Hz	600 Hz	2.5 kHz

**external loss Key**

This key is used to enter an external loss caused by a coupler, amplifier, or cable. Valid entries are  $-30$  to  $+99$  dB. Scaling in linear mode and the reference level in log mode are changed accordingly when a loss is entered. The size of the displayed waveform is not changed.

**sensor zero**

At power levels less than  $10 \mu$ watts, the peak power sensor may contribute an offset that will affect the Peak Power Analyzer's accuracy specification. The sensor zero key eliminates this offset. If the power level is greater than  $10 \mu$ watts and the vertical sensitivity is set to display the signal, the Peak Power Analyzer meets its accuracy specification without the use of the sensor zero key.

Using the sensor zero key is very easy:

- Select the channel to be zeroed.

- The peak power sensor may remain connected to the RF source. If the peak power sensor is disconnected from the RF source, any ground loop currents are not zeroed out.
- If possible, turn the RF source off. Otherwise, disconnect the peak power sensor from the RF source.
- Press the **sensor zero** key. The zeroing takes less than one minute.
- The advisory “Zeroing sensor offset” is displayed during the zeroing process.
- The advisory “Sensor zero completed” indicates when zeroing is complete.

The procedure needs to be repeated when accuracy is a concern for signals less than 10  $\mu$ watts and the peak power sensor has been disconnected from the Peak Power Analyzer since the last zeroing.

---

## Channels 2 and 3

### Vertical Sensitivity Key

The vertical sensitivity key is the third key from the top in the channel menu. The field itself is not labeled. However, the current volts/division is displayed with the units of the current selection. When this function is selected, either of the entry devices can be used for data entry.

The vertical sensitivity range is from 100 mV/division to 500 mV/division. When the knob is used, vertical sensitivity changes in a 1-2-5 sequence. The FINE key can be used with this function. The probe setting will affect the vertical sensitivity units.

**offset Key** When offset is selected, 0 volts is on the vertical midpoint of the display. Offset is the voltage level at mid-screen.

Offset moves the displayed signal up or down, similar to the vertical position adjustment on an oscilloscope. However, offset on the Peak Power Analyzer has a range of  $\pm 16$  divisions from center screen.

**coupling Key** The coupling key has several selection variables:

- ac
- ac bandwidth limit
- dc
- dc bandwidth limit

Bandwidth limit reduces the effective bandwidth to  $\approx 20$  MHz. It reduces the noise in the display path as well as the trigger path.

**more (preset, probe) Key** The more key toggles between the two levels of the channel 2 and 3 menu.

**Channel (more) Key** This key shows the user which channel is being affected. Also, the key allows access to one of the other channels.

**probe Key** The probe key selects probe attenuation with a range of 0.9000:1 to 1000:1. Attenuation is adjusted by either the knob or keypad. When the knob is in coarse mode, adjustments are incremented or decremented in the familiar 1-2-5 sequence. When in FINE mode adjustments are in 0.1 increments

Probe attenuation affects scaling factors for the display, not sensitivity at the input.

Attenuation factors are saved with the front panel setup.

**ECL Key** The ECL key sets the Peak Power Analyzer to levels optimized for ECL circuits:

- V/Div: 200 mV/div
- offset: -1.3 V
- coupling: dc
- Trigger level: -1.3 V
- Trigger slope: no change

RECALL 0 returns the menu to the previous settings.

**TTL Key** The TTL key sets the Peak Power Analyzer to levels that are optimized for TTL circuits:

- V/Div: 1 V/div
- offset: 2.5 V
- coupling: dc
- Trigger level: 1.4 V
- Trigger slope: no change

To return to the previous settings press RECALL 0.

**more Key** The more key toggles between the two levels of the channel 2 and 3 menu.



## Trigger Menu

---

### Introduction to the Triggers

The trigger modes of the Peak Power Analyzer provide many distinctive techniques to trigger and capture data. The triggering capabilities range from simple edge triggering to logic triggering on multiple signals.

This chapter contains descriptions of the triggering modes, explanations on how to use them, and exercises detailing some real life applications. The Peak Power Analyzer has four triggering modes:

- edge
- pattern
- state
- delay

---

### Single Sensor Input Option

When Option 001, Single Sensor Input, is installed, channel 4 is not useable. No error is reported when channel 4 is specified in one of the trigger modes. Although an error is not reported, the Peak Power Analyzer won't trigger on the measured waveform.

---

## Triggering Internally or Externally

**Note**

---

The minimum triggerable pulse width for channels 2 and 3 is 7 ns. Trigger quality for channels 1 and 4 degrades for pulses narrower than 500 ns.

---

For signals  $> -30$  dBm, internal triggering of channels 1 and 4 has a minimum triggerable sensitivity of 25% of full scale and a bandwidth of dc to 1 MHz. At some vertical sensitivities, the Channel Menu low bandwidth setting may have to be used to achieve this minimum triggerable level. External triggering through channels 2 and 3 offers a bandwidth of dc to 100 MHz. Minimum sensitivities are 200 mV from dc to 1 MHz and 500 mV from 1 MHz to 100 MHz.

Since the Peak Power Analyzer has the option of being triggered internally or externally, you may ask the question, "When do I use external triggering over internal triggering?" It is hoped that the following list will aid in answering that question:

- To obtain the specified 5 ns for a risetime or falltime measurement, external triggering must be used.
- When using internal triggering, the displayed risetime and falltime may be a function of the signal noise.
- Internal trigger quality degrades for repetition rates  $> 1$  MHz.

Either channel 2 or 3 can be used for external triggering. However, there is a finite isolation which exists between channels 1 and 2 and channels 3 and 4. Therefore, it is recommended when using external triggering, trigger from channel 3 when measuring with channel 1, and trigger from channel 2 when measuring with channel 4.

**Note**

---

A phenomenon common to all triggered sweep oscilloscope-type instruments is the appearance, under certain conditions, of a “noise hump” at the timebase reference position of the sweep. This can occur when wideband noise is displayed with no other signals above the noise, and with the internal trigger level set near the highest noise peaks. Under these conditions, trigger events occur only on high level peaks in the noise. Since the trigger event always occurs at the same position on the screen (left, center, or right, as selected) the traces of these high level noise peaks appear at this position as an apparent hump or spike in the noise display. Note that a noise hump is extremely unlikely when there are signals present above the noise level. And this will never occur when employing external triggering.

---

---

**Trigger Mode Interaction**

The trigger level (threshold) for each channel is set in the edge trigger mode and is independent for each channel; it is carried over to all other modes. These levels are important settings because the high and low levels in the pattern, state, and delay modes are greater than or less than the trigger level.

---

**Edge Trigger Mode**

The edge trigger mode has the following selections:

- trig'd/auto
- trigger source
- trigger level
- slope
- holdoff

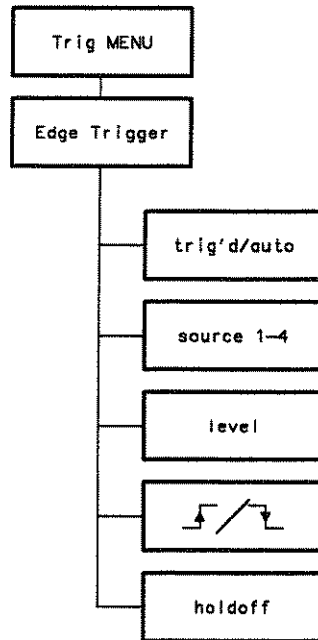

Figure 3-13. Edge Trigger Menu

### Trig'd/auto Key

The trig'd/auto selection toggles between the two trigger modes. The current selection is displayed in inverse video. This field is available in all trigger menus.

In the triggered mode, the Peak Power Analyzer does not acquire data until all of the trigger requirements are satisfied. In the auto mode, the Peak Power Analyzer generates a trigger if one is not present. If a trigger is not found, a trigger is generated and acquired data is displayed. A status message is displayed in the upper left corner of the screen.

If the Peak Power Analyzer is auto-triggered and the sweep speed is 200 ms/div, 500 ms/div, 1 s/div, 2 s/div, or 5 s/div, it operates in the auto triggered scroll mode

and displays data points as they are acquired. For additional information refer to the Timebase Menu.

- source Key** This key selects the trigger source. The options are channels 1-4. The current selection is highlighted in inverse video.
- level Key** The level key sets the trigger level. The range for channels 2 and 3 is  $\pm 6$  divisions from center. For channels 1 and 4 it is +6 divisions from center. This function provides flexibility for setting exact triggering points and specifies levels used in the more sophisticated triggering modes.
- 
- Note** For maximum accuracy, calibration of the Peak Power Analyzer should be performed only if the temperature of the Peak Power Analyzer (not the sensor) has changed significantly. The accuracy error for every degree Celsius deviation from the last calibration is 0.15%/deg. C (0.006 dB/deg. C). A change in temperature will also have an affect on the trigger level accuracy of channels 1 and 4. The vertical calibration procedure which performs this calibration is explained in the Utility Menu section of this manual.
- 
- slope Key** This field is not labeled. However, the available selections are graphic representations of the rising edge and falling edge. The current selection is highlighted in inverse video.
- holdoff Key** Pressing the holdoff key assigns the entry devices to control holdoff. Holdoff disables the trigger circuit for a selectable time period after the trigger event. Holdoff is selected in time units, from 40 ns to 320 ms.

## Holdoff Exercise

This exercise sets up the Peak Power Analyzer and a pulse generator to view some of the features of the edge trigger. Holdoff is used to gain a stable trigger. This technique is not necessary for most applications and waveforms. However, for many non-recurring and irregular waveforms it is useful.

### Pulse Generator Setup

Set the pulse generator as described below. The signal for this exercise is a burst pattern with two positive cycles that repeat every 5  $\mu$ s. Use an HP 8116A Pulse Generator with the burst option or a another instrument capable of the same signal.

Make the following settings:

- MODE: I.BUR
- RPT: 5.00  $\mu$ s
- BUR: 2
- FRQ: 1 MHz
- DTY: 50%
- AMP: 1 V
- OFS: -200 mV
- Signal: square wave.

### Peak Power Analyzer Setup

- Connect the pulse generator to channel 2.
- Remove any inputs to the other channels.
- Press the **DISPLAY** menu key.

Press **connect dots** until **on** is highlighted.

- Press **AUTOSCALE**. See figure 3-14.

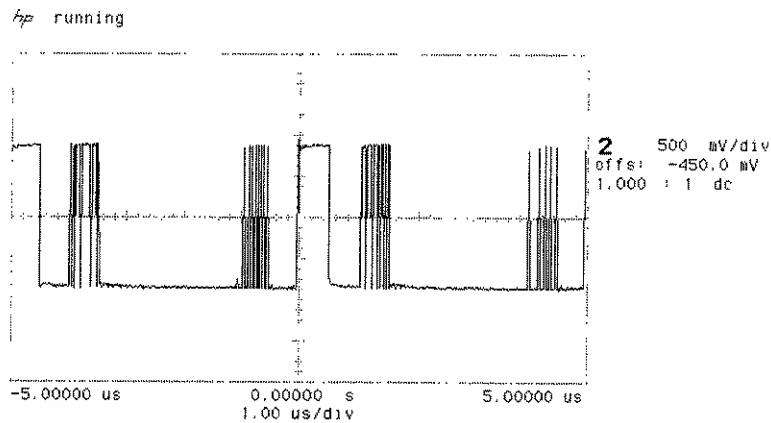

2  $\sqrt{\text{}}$  -178 mV

**Figure 3-14. Two-Burst Waveform after Autoscale**

- Select the **TIMEBASE** menu key.
- Set the timebase to 500 ns/division.

Change the timebase with the knob or the keypad.  
If the keypad is used, terminate the entry with a  
suffix key on the rightside of the keypad.

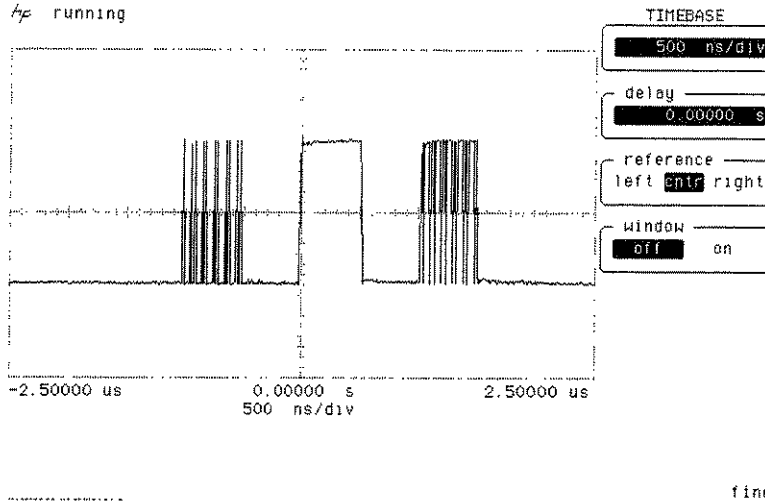

**Figure 3-15. Two-Burst Pulse**

The Peak Power Analyzer sets up the display parameters. It is now attempting to trigger on the first rising edge of the two cycle burst.

- Select the **TRIGGER** menu key.
- Press the **slope** key. This is the softkey below **level**.

The Peak Power Analyzer is now triggering on the first falling edge of the two cycle burst. Press the **slope** key again to trigger on the positive edge.

### Note

The pulse generator is set for two 500 ns pulses. The display on the Peak Power Analyzer appears to have three pulses. This is an unstable trigger condition. The following steps explain this condition and how to overcome it.

- Press the **holdoff** softkey.
- Set holdoff to 1.02000 ms, using either of the entry devices.



Holdoff on the Peak Power Analyzer has a minimum setting of 40 ns. The input signal to the Peak Power Analyzer has two 500 ns pulses. On the first rising edge a trigger occurs and activates the 40 ns holdoff. When the holdoff time has elapsed the Peak Power Analyzer triggers on the next rising edge. The Peak Power Analyzer times a 40 ns holdoff and looks for another trigger. The Peak Power Analyzer will trigger on the first rising edge of the second pulse. Each trigger event occurs on a different pulse, and consequently an unstable condition.

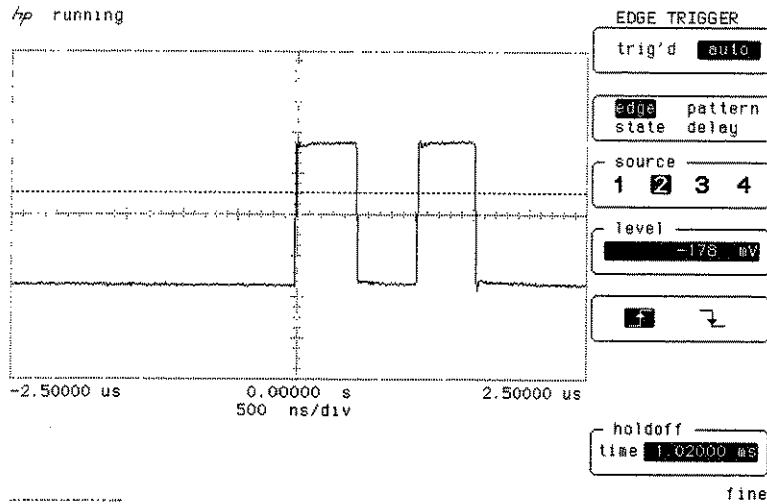

Figure 3-16. Two-Burst Pulse w/Stable Trigger

By adjusting the holdoff to wait until the rising edge of the second pulse passes, the Analyzer triggers only on the first rising edge and the signal is stable. In this case the trigger becomes stable at approximately 1.02 ms holdoff.

## Pattern Trigger Mode

Pattern trigger mode defines a four-character pattern for the Peak Power Analyzer to recognize and then generate a trigger event. When the inputs satisfy the trigger pattern and conditions, the Peak Power Analyzer triggers and displays the desired portion of the waveform.

Pattern trigger mode is very useful for glitch detection, because the Peak Power Analyzer triggers on a glitch and displays the resulting waveform.

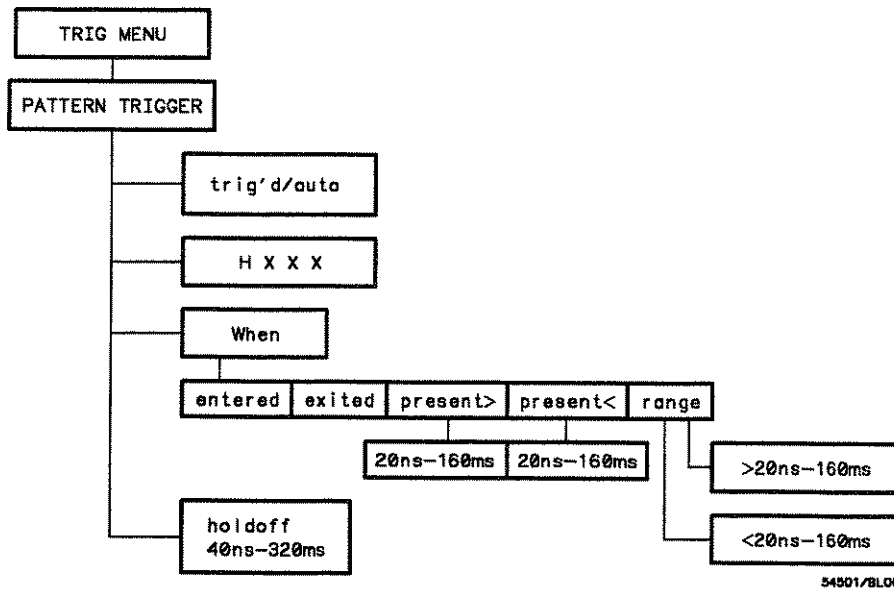

Figure 3-17. Pattern Trigger Menu

The top two function keys remain the same as the Edge Trigger mode.

**pattern Key**

This is an unlabeled field. The display depicts the 4-bit pattern. The active field is displayed in fullbright and is changed with the function key. The knob changes the active bit selection level. Three levels are possible:

- H-high
- L-low
- X-don't care

The criteria for high is higher than the current trigger level, and low is lower than the current trigger level.

The 4-bit pattern is representative of the four-channel input.

For example, if the pattern is LXXH, the power on channel 1 must be lower than the trigger level set for channel 1, channels 2 and 3 are don't cares so the input levels are disregarded, and the channel 4 input must be higher than the trigger level set for channel four. If these conditions are satisfied by the inputs, the Analyzer generates a trigger event.

**Note**

---

When any channel is not being used in the qualifier pattern, it should be set as don't care. The trigger level is still compared to the no input channel and a high or low is determined. The only true don't care is X.

---

If the pattern XXXX is selected, a trigger event does not occur because a trigger event is not defined.

**when Key**

This key controls five sets of conditions that must be satisfied to generate a trigger event. These conditions are as follows:

- **when entered:** a trigger is generated on the first transition that makes a pattern true. The pattern must be false and go true to generate the trigger.

- **when exited:** a trigger is generated on the first transition that makes the pattern false. The pattern must be true and go false to generate a trigger.
- **when present >:** a trigger is generated when a trigger pattern is true longer than a specified minimum time period. This time period is specified in the next selection key that is activated when **present >** is selected. The **present >** time ranges from 20 ns to 160 ms.
- **when present <:** a trigger is generated when a trigger pattern is true less than a specified maximum time period. This time period is specified in the next selection key that is activated when **present <** is selected. The **present <** time ranges from 20 ns to 160 ms.
- **range:** this trigger condition is a combination of **present <** and **present >**. A trigger is generated when a trigger pattern is true for longer than a specified minimum and shorter than a specified maximum time period. These time periods are specified in the next two selection keys that are activated when **range** is selected. The first range time setting must be less than the second range time setting.

**holdoff Key**

The holdoff key assigns the entry devices to control holdoff. Holdoff disables the trigger circuit for a selectable time period after the trigger event. Holdoff is selected in time units, from 40 ns to 320 ms and is incremented in 20 ns intervals.

---

## Pattern Trigger Exercise

This exercise demonstrates how to define the 4-bit pattern and how it affects the trigger and the resulting display.

### Note

---

Set the trigger level for each trigger source while in edge trigger mode. These trigger levels must be set before you go to the pattern mode, or proper triggering may not occur.

---

## Pulse Generator Setup

To perform the following exercise use the HP 8116A Pulse Generator, or another pulse generator capable of producing the same type of signal.

Set up the Pulse Generator as follows:

- Mode = NORM
- FRQ = 1.00 MHz
- DTY = 50%
- AMP = 1.00 V
- OFS = -200 mV
- Pulse = squarewave

Connect a BNC tee to channel 2 of the Peak Power Analyzer. Place a 50  $\Omega$  load on one side of the tee, and another BNC tee on the other side. Connect the signal from the pulse generator to one side of the second tee using a one meter coaxial cable. With another one meter cable, connect the other side of the second tee to a BNC tee on channel 3. Place a 50  $\Omega$  load on the other side of the tee on channel 3. The extra cable length between channels 2 and 3 provides a time delay between the signals displayed on the Peak Power Analyzer. The propagation of a one metre coaxial cable is approximately 6 to 7 ns. This time delay is used to demonstrate the Peak Power Analyzer's triggering capability.

**Peak Power Analyzer  
Setup**

- Press **AUTOSCALE**.
- Select the **TIMEBASE** menu key.
- Set the following timebase parameters, using the knob or the keypad. Keypad entries need to be terminated with one of the suffix keys on the rightside of the keypad:
  - Timebase = 10.00 ns/div
  - delay = 0.00 s
  - reference = cntr
  - window = off
- Select the **CHAN/VERT** menu key.
- Set the following channel 2 parameters:
  - Vertical sensitivity = 500 mV/div
  - offset = -200.00 mV
  - dc coupling
- Set the following channel 3 parameters:
  - Vertical sensitivity = 500 mV/div
  - offset = -200.00 mV
  - dc coupling
- Select the **DISPLAY** menu key.
- Set the following display parameters:
  - Mode norm
  - minimum persistence
  - 2 screens
  - axes
- Select the **TRIG** menu key.
- Set the following trigger parameters:
  - Channel 2 level = -200 mV
  - Channel 3 level = -200 mV
  - Set the trigger mode to pattern.

Press the second softkey until **pattern** is highlighted.

- Set the pattern to XHLX as follows:

Press the third function key until the first character is highlighted.

Turn the knob until the highlighted area is an H.

Select the next character in the pattern and repeat the procedure.

Continue until all characters are selected in the XHLX pattern.

Press the **when** key until **entered** is selected.

The display should be similar to the following figure.

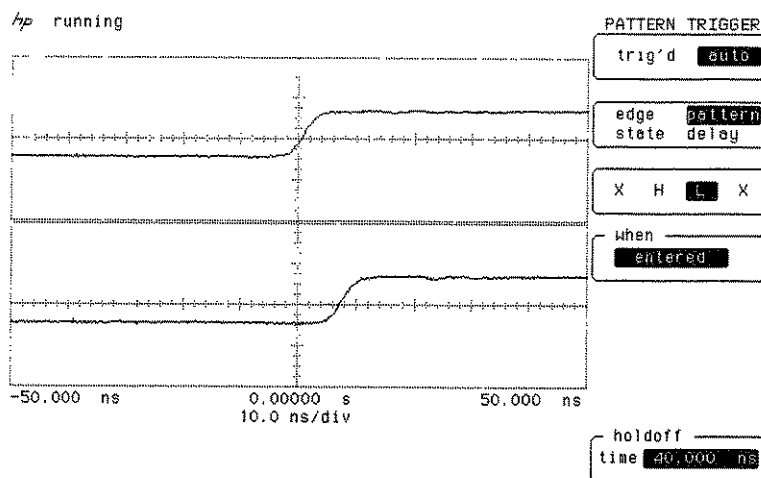

**Figure 3-18. XHLX when entered Pattern**

Channel 2 is displayed in the top screen. To satisfy the conditions of the bit pattern, channel 2 must be high (higher than the channel 2 trigger level) or greater than  $-200$  mV. When the signal on channel 2 goes higher than  $-200$  mV and channel 3 is still low (less than  $-200$  mV) the pattern conditions have been satisfied as the

signal is entering the trigger conditions, and the Peak Power Analyzer triggers.

- Press the **when** key and change the condition to **exited**.

The Analyzer triggers on the first transition that makes the bit pattern false, in this case when channel 3 goes high.

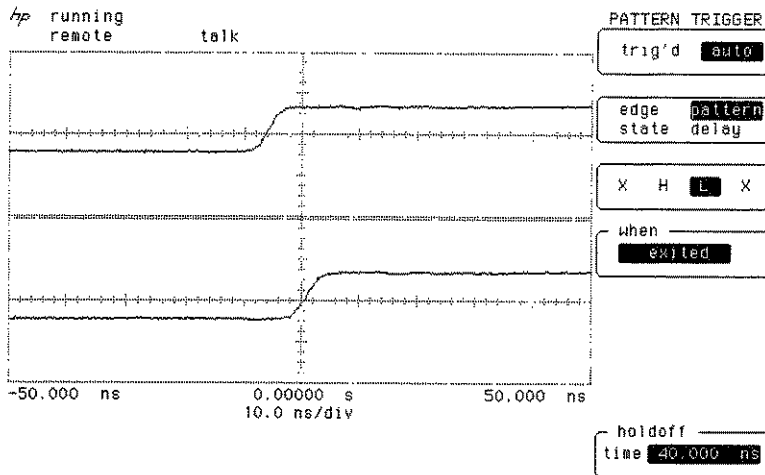

**Figure 3-19. XHLX when exited Pattern**

- Change the bit pattern to XHHX and select the **entered** condition.

To satisfy this bit condition both channels must be high. The Peak Power Analyzer does not trigger until channel 3 goes high while channel 2 is high.



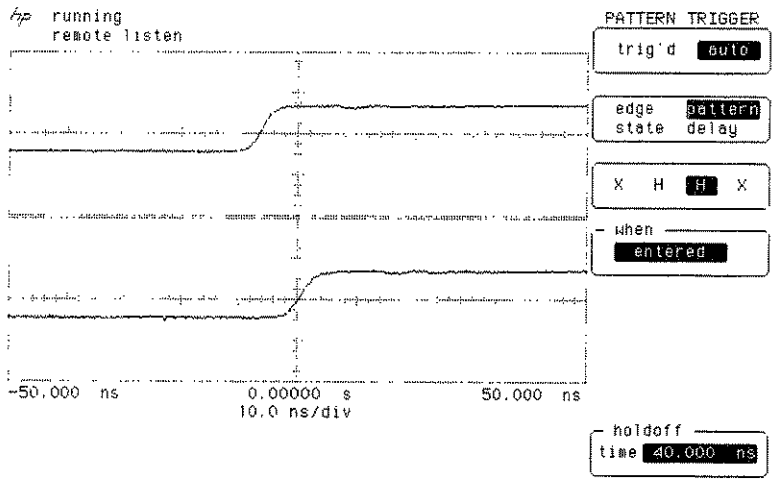

Figure 3-20. XHHX when entered Pattern

- Change the trigger condition to **when exited**.

When channel 3 is high, and channel 2 goes low, the bit pattern is no longer true, and the Peak Power Analyzer triggers.

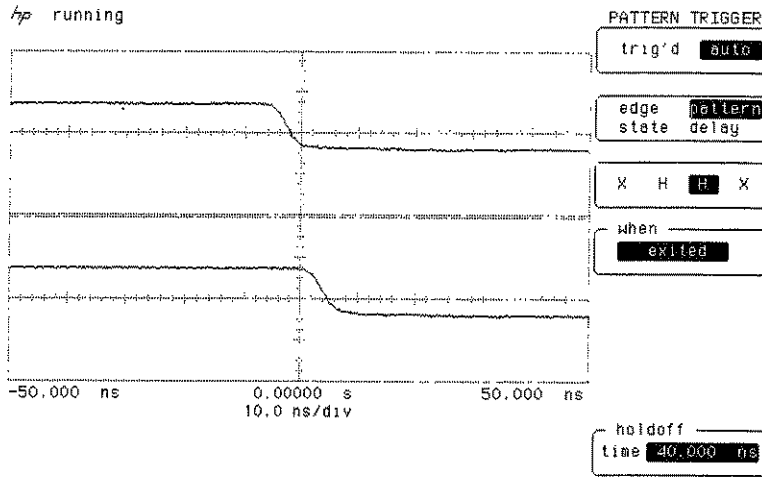
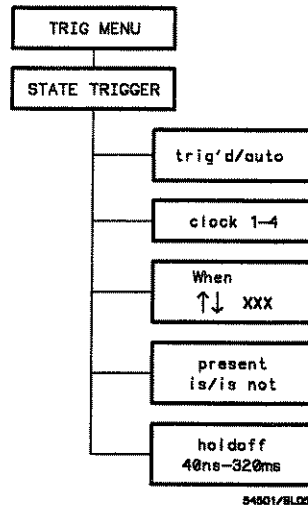

Figure 3-21. XHHX when exited Pattern

### State Trigger Mode

State trigger mode is similar to pattern trigger mode except that one channel is selected as a clock edge and the other three channels define a pattern. When the pattern becomes true, the Peak Power Analyzer triggers on the next clock edge, if the pattern meets setup and hold criteria.



**Figure 3-22. State Trigger Menu**

The **trig'd/auto** and trigger mode function keys remain displayed in all trigger modes.

**clock Key** Select any channel to be used as the state clock. Select the channel by pressing the function key until the desired channel is highlighted. The clock selection is reflected in the next field with an arrow, pointing either up for a positive slope or down for a negative slope.

**when Key** The **when** key depicts the desired pattern. The displayed pattern shows the arrow at the selected clock channel. The other three channels define the logic pattern that must be satisfied to generate a trigger event using the H, L, X convention described in the Pattern Trigger Mode.

To change the pattern:

- Press the function key until the bit to be changed is highlighted.

- Rotate the knob until the desired setting is highlighted.
- Select the arrow to change the trigger slope, if necessary, and turn the knob until the desired settings appear.

**present Key** A trigger event is generated on the selected edge when the pattern is true and **is present** is selected, or a trigger occurs when the pattern is false and **not present** is selected.

**holdoff Key** The holdoff key assigns the entry devices to control holdoff. Holdoff disables the trigger circuit for a selectable time period after the trigger event. Holdoff is selected in time units, from 40 ns to 320 ms.

---

## State Trigger Exercise

This exercise demonstrates how an input pattern is used to qualify a clock edge as a trigger.

State triggering extends the logic triggering capability of the Peak Power Analyzer by selecting one of the inputs as a clock and using the other inputs as qualifiers.

This is useful when it is necessary to synchronize the display with a system clock to detect a system state. For example, consider a synchronous memory bus. State trigger mode enables you to see only those events that occur when reading from a block of memory.

**Pulse Generator Setup**

To perform the following exercise use an HP 8116A Pulse Generator or another pulse generator capable of producing the same signal.

Set up the Pulse Generator as follows:

- Mode = NORM
- FRQ = 1.00 MHz
- DTY = 50%
- AMP = 1.00 V
- OFS = -200 mV

Connect a BNC tee to channel 2 of the Peak Power Analyzer. Place a 50  $\Omega$  load on one side of the tee, and another BNC tee on the other side. Connect the signal from the pulse generator to one side of the second tee using a one meter coaxial cable. With another one meter cable, connect the other side of the second tee to a BNC tee on channel 3. Place a 50  $\Omega$  load on the other side of the tee on channel 3. The extra cable length between channels 2 and 3 provides a time delay between the signals displayed on the Peak Power Analyzer. The propagation of a one metre coaxial cable is approximately 6 to 7 ns. This time delay is used to demonstrate the Peak Power Analyzer's triggering capability.

**Peak Power Analyzer Setup**

- Press **AUTOSCALE**.
- Select the **TIMEBASE** menu key.
- Set the following timebase parameters.

Timebase = 10.00 ns/div

delay = 0.00 s

reference = cntr

window = off

- Select the **CHAN/VERT** menu key.

- Set the following channel 2 parameters.
  - Vertical sensitivity = 400 mV/div
  - offset = -125 mV
  - dc coupling
- Set the following channel 3 parameters.
  - Vertical sensitivity = 400 mV/div
  - offset = -125 mV
  - dc coupling
- Select the **DISPLAY** menu key.
- Set the following display parameters
  - minimum persistence
  - 2 screens
- Select the **TRIG** menu key.
- Set the following trigger parameters while in edge trigger.
  - Channel 2 level = -125 mV
  - Channel 3 level = -100 mV
  - Set the trigger mode to state
- Set the pattern to X↑LX as follows:
  1. Press the function key until the first bit is highlighted.
  2. Turn the knob until the highlighted area is X.
  3. Select the next bit in the pattern and select ↑
  4. Continue until all bits are selected in the X↑LX pattern
- Press the **when** key until **is present** is selected (see figure 3-23).

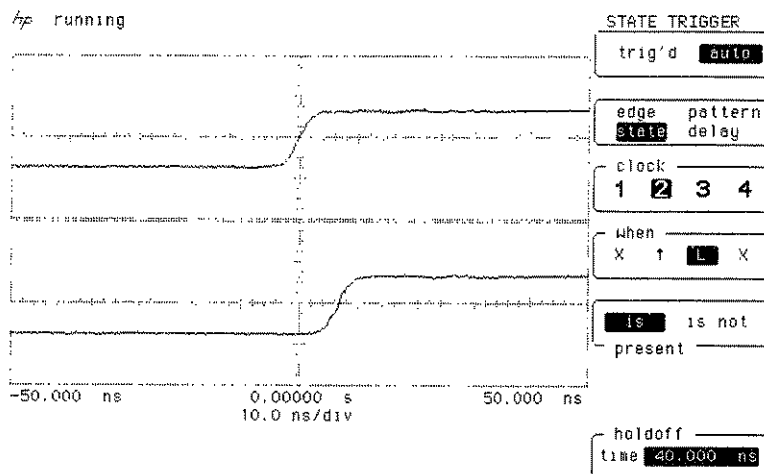

Figure 3-23. X↑LX State

Channel 2 is displayed in the top screen. To satisfy the conditions of the bit pattern, channel 3 must be low (lower than the channel 3 trigger level) or less than -100mV. When the signal on channel 2 goes higher than -125 mV and channel 3 is still low (less than -100 mV), the pattern conditions have been satisfied, and the Peak Power Analyzer triggers on the next positive pulse on channel 2.

- Press the **present** key and change the condition to **is not**.

The pattern becomes false when channel 3 turns high.

- Change the bit pattern to X↓HX and select the **is present** condition.

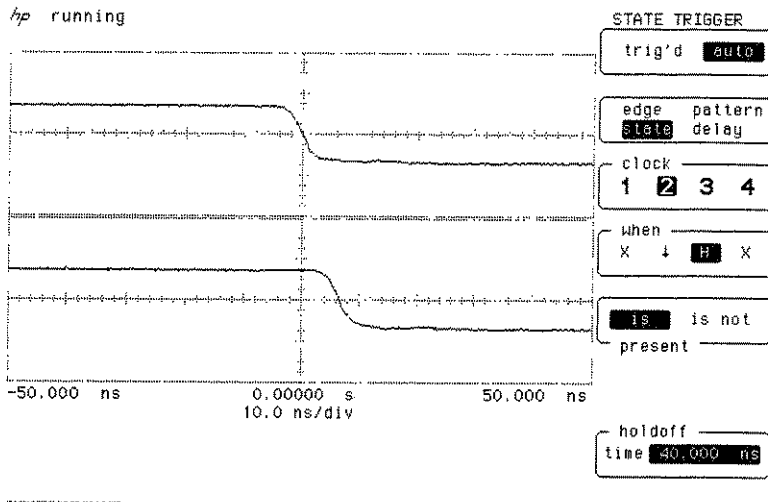

Figure 3-24. X|HX State

To satisfy this bit condition, the clock channel must go low while channel 3 is high. The Peak Power Analyzer does not trigger until channel 2 goes low while channel 3 is high.

### Delay Trigger Mode

Delay Trigger mode qualifies on a signal edge, pattern, or state delay for a period of time (or occurrence of edges), and then triggers on a selected edge from any source.

This trigger mode is versatile and accommodates most complex triggering situations. It has the flexibility to select different trigger sources, delay times, and delay counts, and then, display various points of the waveform.



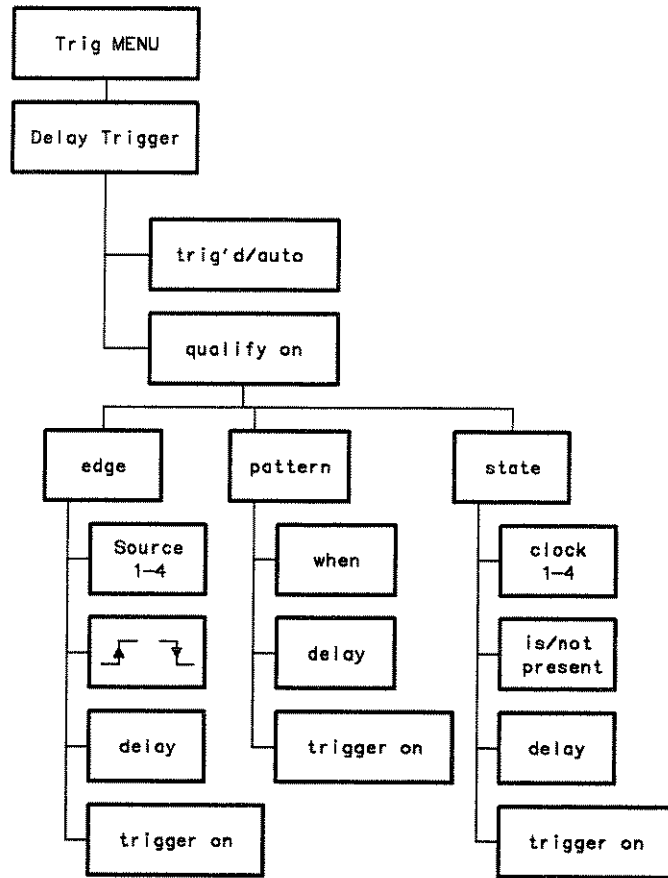

Figure 3-25. Delay Trigger Menu

**qualify on Key** The **qualify on** key allows you to select which mode to qualify the trigger on before a delay is defined.

The options are:

- edge
- pattern
- state

**edge Qualify Option**

Select the edge qualifier, and the next two function keys are used to define the parameters. The first key is an unlabeled field that selects the channel to be the source. The second key is the slope selection.

**pattern Qualify Option**

When the pattern trigger option is selected, the next function key defines the qualifier pattern. Defining a pattern is the same as in Pattern Trigger mode.

- Highlight the bit to be changed by pressing the function key.
- Change the bit by rotating the knob.

After selecting through all four bits, the active field is changed to the condition field. This field sets conditions as in Pattern Trigger mode:

- when entered
- when exited
- when present >
- when present <
- range

These settings activate the next field, as appropriate, so the specific time parameters can be set.

**state Qualify Option**

If the state trigger option is selected, the next two function keys define the state conditions.

As in State Trigger mode, select the channel to define the state clock. This selection is reflected in the pattern with an arrow. The slope is depicted with the arrowhead pointing up or down. Use the function key to move the highlighted bit to change the pattern; the knob changes the bit level. When the pattern is set, the **is/not present** setting can be changed by moving the highlight to the **is/not present** field label. When the label is highlighted, toggle the setting between **is/not present** with the knob.

**delay Key** This field selects between two delay options. To change between the time and count options, rotate the knob until the desired option is displayed in the inverse video field.

**delay time** disables the trigger circuit for a selected period of time, from 30 ns to 160 ms after the trigger has been qualified

**Note** Time delay is not available in the time qualified pattern settings of when present >, when present <, or range

- Press the function key until the highlight is on the first numeric field. This field selects the amount of delay after qualification, ranging from 30 ns to 160 ms.

**delay count** (delay by edges) disables the trigger circuit for a selected count from 1 to 16,000,000 after the trigger has been qualified. After the selected count has been attained, the Peak Power Analyzer will look for the user specified trigger edge.

- Press the function key until the highlight is on the first numeric field. This field selects the number of edges to delay after the trigger has been qualified (from 1 to 16,000,000).
- Press the function key once more to activate the **rising edge/falling edge** option, and select the desired edge using the knob.
- Press the function key once more to highlight the third option field, and select the channel to delay on.
- Press the function key a fourth time to return to the first numeric field.

**trigger on Key**

This key selects a specific edge to trigger on after the qualification and delay conditions have been satisfied. All other keys in this menu have dealt with defining qualifying conditions. However, this field sets the trigger point. This is another three position option switch.

- Press the function key to highlight the numeric field and select which occurrence to trigger on. Use the knob to set the occurrence (1 to 16,000,000).
- Press the function key again to move the highlight to the slope. The knob toggles the selection between rising and falling edge.
- Press the function key again, and highlight the channel selection. The knob is used to change the channel selection.

---

**Delay Trigger Exercise**

This exercise demonstrates delay trigger mode and describes how to trigger on a specific point of a waveform.

**Pulse Generator Setup**

Set up an HP 8116A Pulse Generator, or another pulse generator, to produce a burst pulse with ten bursts that repeats every 50  $\mu$ s.

Set up the HP 8116A Pulse Generator:

- Mode = LBUR
- RPT = 50  $\mu$ s
- BUR = 10
- FRQ = 5.0 MHz
- DTY = 50%
- AMP = 1.00 V
- OFS = -200 mV

Connect the signal to channel 2 of the Peak Power Analyzer.

### Peak Power Analyzer Setup

Autoscale will be used to display the signal. However, for our purposes it is necessary to make triggering changes.

- Press the **DISPLAY** menu key.

Press **connect dots** until **on** is highlighted.

- Press **AUTOSCALE**.

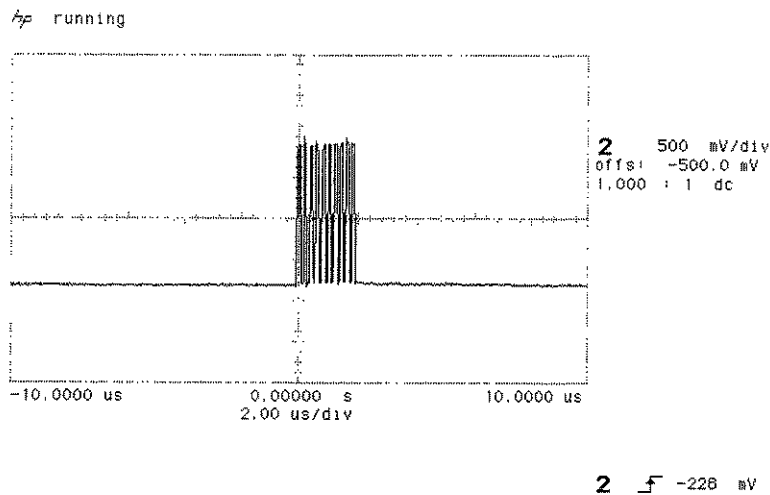

**Figure 3-26. Ten Burst Pulse after AUTOSCALE**

- Select the **TRIG** menu key.
- Make the following trigger selections.
  - Highlight **trig'd**.
  - Highlight **delay** trigger mode.
  - Press **Qualify on** until **edge** is highlighted.
  - Press the fourth softkey until **2** is highlighted.
  - Set the slope to rising edge.

Select a **delay time** of 2.5 ms to gain a stable trigger.

Highlight the area next to **delay**. Use the knob if **time** is not displayed.

Highlight the area below **time**. Set the time with the knob or the keypad. If the keypad is used, terminate the entry with one of the suffix keys.

Set **trigger on** to trigger on rising edge 1 of channel 2.

Highlight the area next to **count**. Use the knob to enter a **1**.

Highlight the slope. With the knob set the slope to positive.

Highlight the area next to the slope. Set that area to **2** using the knob.

This trigger setup qualifies on the first rising edge of the burst, delays through the remaining portion of the burst, and then triggers on the specified edge of the next burst.

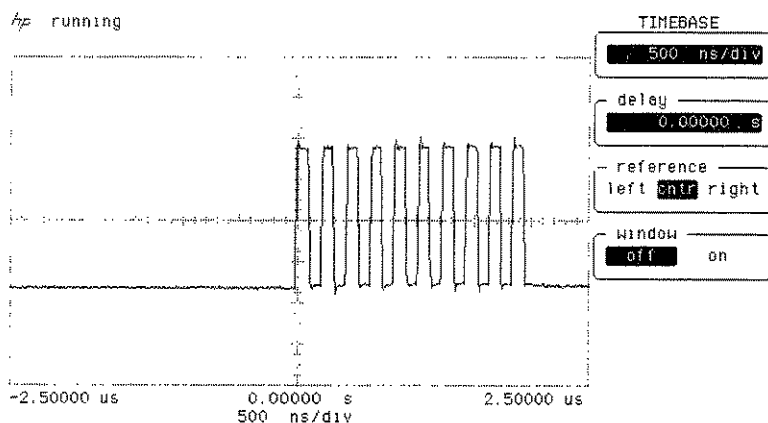

Figure 3-27. Ten Burst Pulse w/Stable Trigger

- Select the **TIMEBASE** menu key.
- Set the time/division to 500 ns.
- Return to the trigger menu and set **trigger on count** to 5. It will be necessary to use the **FINE** key to set the **trigger on count**. This tells the Peak Power Analyzer to trigger on the 5th rising edge of the burst (see figure 3-28).

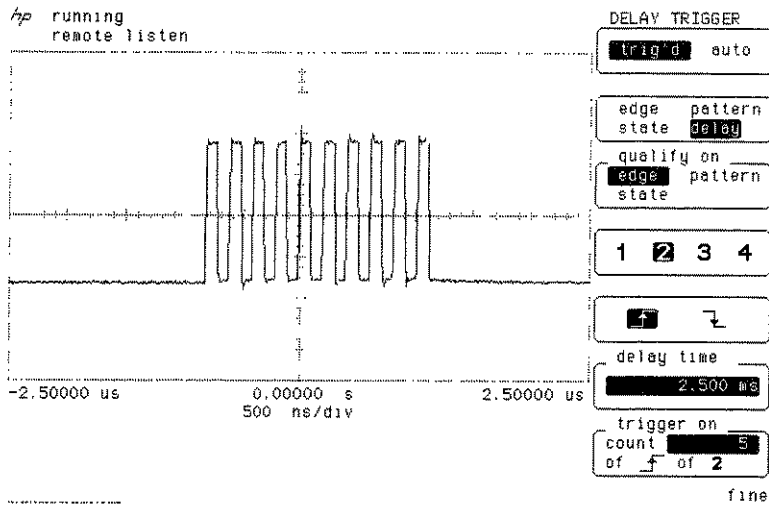

Figure 3-28. Ten Burst Pulse Triggered on Pulse 5

- Change the trigger on count to 9 (see figure 3-29).

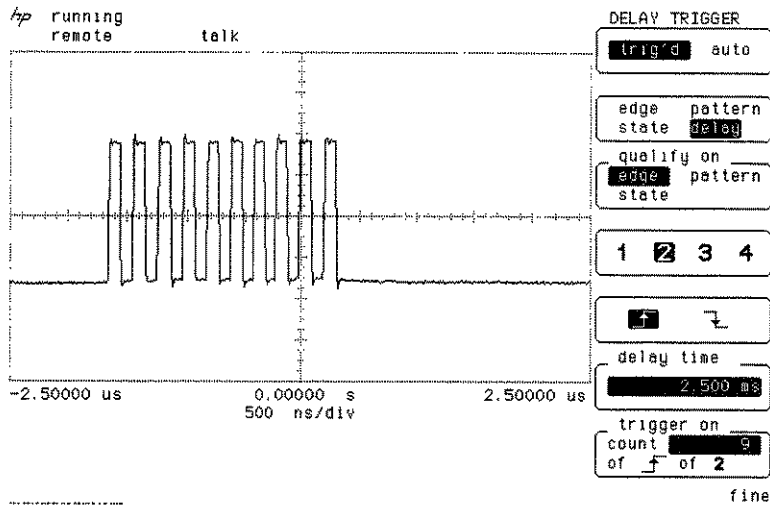

Figure 3-29. Ten Burst Pulse Triggered on Pulse 9



By setting the Peak Power Analyzer to the delay trigger mode, a specific time or count to delay between qualification and trigger can be added.

In this exercise, the trigger was delayed to get a stable display. When the time delay had elapsed the Peak Power Analyzer began counting rising edges until it found the edge set.

**3-74 This Page Intentionally Left Blank**

# Display Menu

## Introduction to the Display

The Display menu controls most of the features that dictate how the acquired data is displayed. These features include ways to manipulate data for clarity and eliminate noise, view best case/worst case situations, and control of the displayed background.

This chapter describes the Display menu, three submenus, how to control all the features, and how to display the most meaningful waveform for measurements.

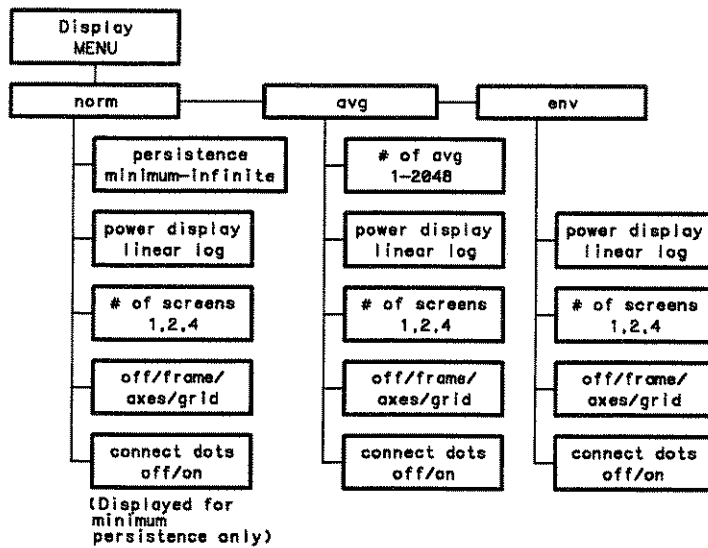

Figure 3-30. Display Menu

---

**Display Mode Key**

The Display mode key selects from one of the three display modes:

- normal
- averaged
- envelope

---

**Note**

If it is necessary to display a very narrow pulse width, increasing persistence or using envelope mode will help.

---

**norm**

The **norm** mode sets the time parameters for displaying data or persistence. The range in the variable persistence mode is from minimum, very fast overwriting and updating the display, to infinite with variable settings in between, from 200 ms to 10 seconds. This means data display records can be preset to any of the persistence settings. Settings less than infinite will display data for the specified period of time and then overwrite old data.

- Minimum persistence is very fast overwrite. As each new acquisition is displayed it overwrites the previous data. The current display is always the most recent acquisition.
- Fast persistence settings are useful when the input signal is changing and immediate feedback is needed.
- More persistence is useful when observing long-term changes in the signal or low signal repetition rates.
- Infinite persistence can be used for worst-case characterizations of signal noise, jitter, or drift, etc. In this mode, the Peak Power Analyzer is used as a storage oscilloscope.

When the keypad is used to change persistence settings, any entry longer than 10 seconds displays the message *value out of range, set to limit* and persistence is set to

**infinite.** Any entry less than 200 ms displays the same message and persistence is set to **minimum**.

When **norm** is selected, the function key beneath the norm field is activated. This field displays the current persistence setting and is set with either of the entry devices. Connect the dots is only available when minimum persistence is selected.

**avg** Averaged mode selects the number of waveform acquisitions that are averaged to generate the displayed waveform. The range for the averaging function is 1-2048 in powers of 2.

When averaged mode is selected, the next function key is activated, and the number of averages is set with either entry device.

Displayed signal noise is significantly reduced using the averaging mode. As the number of averages is increased from 1 to 2048, the display becomes less responsive to changes in the input signal(s). However, using more averages reduces the effects of displayed signal noise and improves resolution.

**env** Envelope mode needs no other parameters set. The display reflects the minimum and maximum amplitude in each horizontal position. This is useful in viewing jitter in time or amplitude.

---

**power display Key**

This function allows the user to toggle between linear and log power display modes. Linear mode is the default power-up mode.

Changing modes does not cause the display to be cleared.

---

**no. of screens Key**

The next function key chooses the number of screens to view:

- **1:** the entire display area is one screen and any displayed waveforms are superimposed on top of each other.
- **2:** the display area is divided into two screens. Channels 1 and 2 will be displayed in the top screen and channels 3 and 4 will be displayed in the bottom screen (See figure 3-31).
- **4:** the display is divided into four equal screens with one waveform displayed in each screen (See figure 3-32).

**Note**

---

If the display has more windows than are desired, it may be that additional windows have been enabled with the **Timebase Menu** or the **Wform Math Menu**. Select these menus to turn off the undesired windows.

---

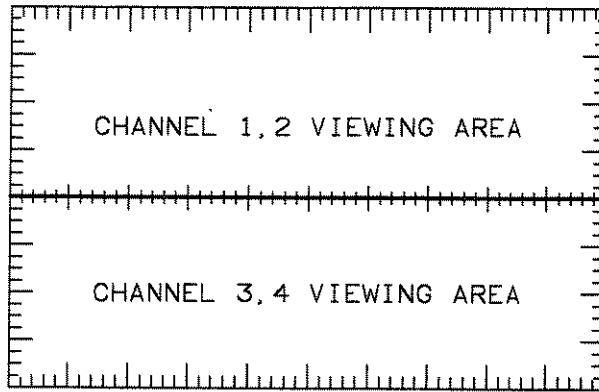

**Figure 3-31. Dual Screen Display**

When waveform math functions or the dual timebase window are turned on, they are displayed in the lower half of the screen, and the channels are displayed in the top half.

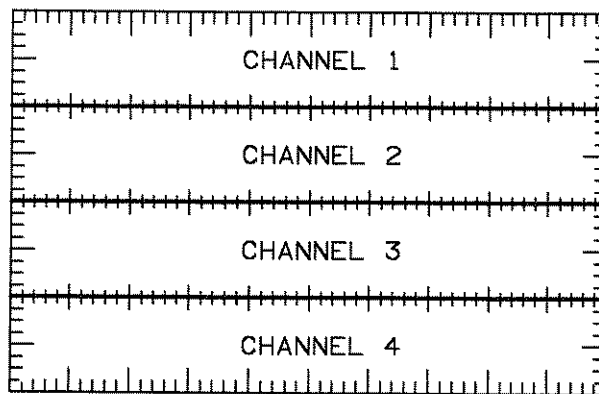

**Figure 3-32. Quad Screen Display**

---

**off/frame/  
axis/grid Key**

This unlabeled field selects one of four display backgrounds:

- **off:** The off option turns the background graticule off. The displayed waveform and waveform information is not turned off.
- **frame:** The frame option displays the outside border with a measurement scale. The measurement scale is incremented/decremented with major divisions and minor divisions based on the vertical and horizontal measurement settings.
- **axes:** The axes setting displays a background with the measurement scale crossing at mid-screen.
- **grid:** The grid background is a complete graticule with ten horizontal major divisions and eight vertical major divisions. Only the axis portion of the graticule has a minor division scale.

---

**connect dots Key**

Connect the dots is a technique used to display a waveform with all data points connected. This makes viewing the waveforms easier because the signal is complete and has no breaks. Connect the dots is available in display modes average and envelope. However, it is only available with minimum persistence in normal mode.

**Note**

---

Connect the dots does not interpolate data and generate data points. The Peak Power Analyzer connects data points linearly.

---



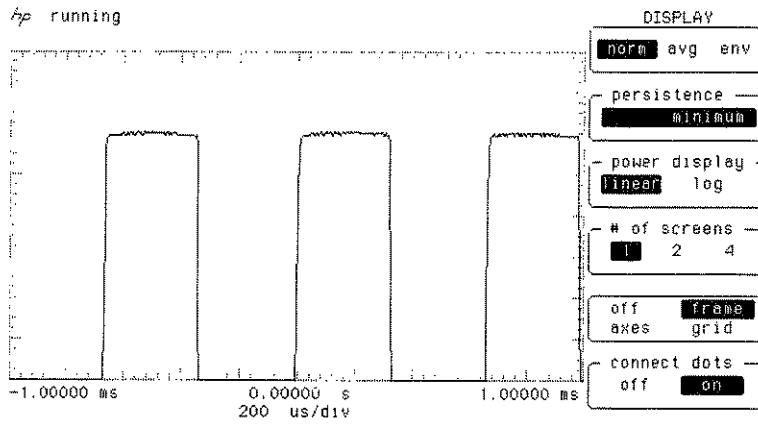

Figure 3-33. Connect the Dots

**3-82 This Page Intentionally Left Blank**

## Markers Menu

---

### Introduction to Markers

This chapter describes how to use the markers and make manual measurements on displayed waveforms.

In this menu, two sets of markers are controlled. These markers are the **amplitude markers** (power and voltage; horizontal line markers) and the **time markers** (vertical line markers). When the desired set of markers have been turned on, the two marker fields are turned on. The markers are controlled individually.

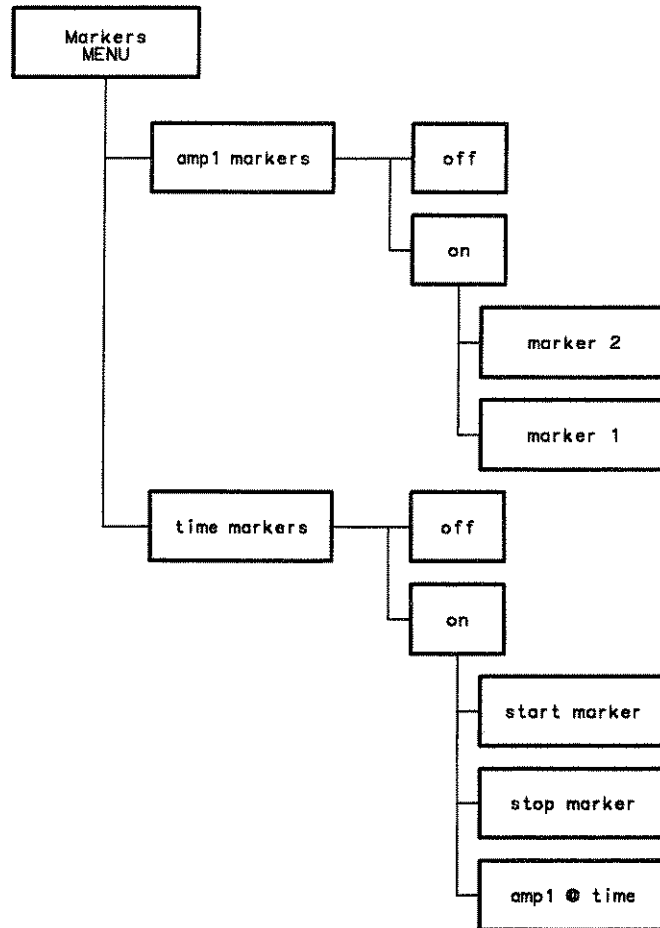

Figure 3-34. Markers Menu

**ampl markers**

This function key toggles the markers on and off. With the amplitude marker function turned on, the next two fields are activated; the two markers are controlled individually.

When the amplitude markers are turned on, *marker 2*, *marker 1*, and *delta ampl* appears in the factors display area. The delta ampl entry is calculated as the following:

$$\text{marker 2} - \text{marker 1} = \text{delta ampl}$$

If delta ampl is negative, marker 1 is located at a more positive amplitude than marker 2.

**marker 2**

This function key is a two function control field. The first function selects the desired channel, memory, or function to place marker 2 for measurement. By pressing the function key again, the highlighted field moves to the numeric display to select the amplitude level. Typically, place marker 2 at the desired level on the waveform display and read the level, both in the highlighted field, and in the factors area of the waveform display.

Marker 2 is the amplitude marker with shorter dashes.

**marker 1**

Marker 1 operation is identical to marker 2, except it is represented by longer dashes.

---

**time markers**

This function key toggles the time markers on and off. With the function turned on, the next two fields are activated; the two markers are controlled individually

The markers are placed on the display respective of the trigger point. Positive time values are to the right of the trigger point, and negative time values are to the left. Delta t values are determined by the following:

$$\text{stop marker} - \text{start marker} = \text{delta t}$$

A negative delta t, means that the start marker is placed later in time than the stop marker.

$1/\text{delta t}$  is the inverse of delta t. Since the inverse of time is frequency, this ratio produces an answer in hertz. However, be alerted that if the markers are placed across parts of a waveform of differing time frames, the answer may not be valid. This feature is useful when looking for the frequency in a burst that is different from the rest of the waveform. Place the time markers across the burst (at similar points on the waveform) and determine the frequency of the burst.

**start marker**

To set the start marker, press the function key to highlight the field. This makes the start marker field active. Set the marker using the knob.

The start marker is represented with long dashes.

**stop marker**

The stop marker is identical to the start marker, except that it is represented by short dashes.

**ampl @ time mkrs**

This key is available if the time markers have been turned on. The key is used to make an amplitude measurement at a specific point on a waveform. The measurement can be made on a channel, memory, or function. The result is shown at the bottom of the display. The delta between the two markers is also available.

**Note**

---

Before making an *amplitude-at-time* measurement on a waveform in memory, be sure the current timebase is set to the timebase of the stored waveform.

---

Press the key repeatedly. Observe how the highlight moves from field to field. The top field turns the feature on or off. The two fields on the left select where the measurement will be made: channel, memory, or function. The two fields on the right select the marker that will be used to make the measurement: start marker or stop marker. When a field has been highlighted, change the field by using the knob.

**3-88 This Page Intentionally Left Blank**



## Carrier Frequency Menu

### Introduction to the Carrier Frequency

The Peak Power Analyzer has two power channels (channels 1,4). This chapter describes how to specify the carrier frequency of the pulsed or CW source being measured. The frequency is used to look up calibration data in the peak power sensor's internal table of calibration factors. Specifying the carrier frequency is necessary to make accurate power measurements. The carrier frequencies can be set independently or simultaneously.

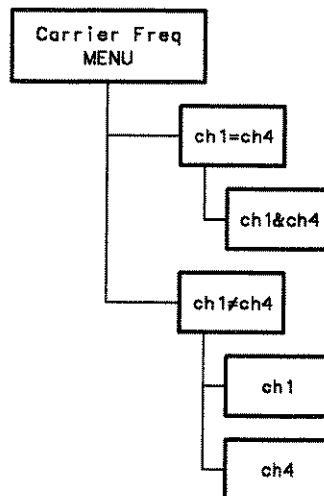

Figure 3-35. Carrier Frequency Menu

---

**Channel Selector  
Key**

This key is labeled CARRIER FREQ. It is used to choose whether the carrier frequencies seen at the sensor inputs are different (ch1, ch4) or the same (ch1 & ch4). The active area is highlighted



**Channels 1 and 4  
coupled**

This key is displayed when the selection is made to set the carrier frequencies to the same frequency. The field is highlighted when selected and ready for data entry. Valid entries are 1 MHz to 200 GHz. Data is entered using the knob or the numeric keypad. With the numeric keypad, terminate data entry using the MHz or GHz keys.

**Channels 1 and 4  
separate**

Two fields are displayed when the selection is made to set the carrier frequencies separately. A field is active when it is highlighted. Valid entries are 1 MHz to 200 GHz. Data is entered using the knob or the numeric keypad. With the numeric keypad, terminate data entry using the MHz or GHz keys.



## Waveform Math Menu

---

### Introduction to the Functions

The Waveform Math function defines one and/or two functions. The functions are used on data that is displayed on screen from any of the four channels or from any of the four waveform memories.

A function is generated by mathematically manipulating one or two operands with known operations. The Peak Power Analyzer uses these mathematical operations:

- plus (+)
- divide (/)
- minus (-)
- versus
- only

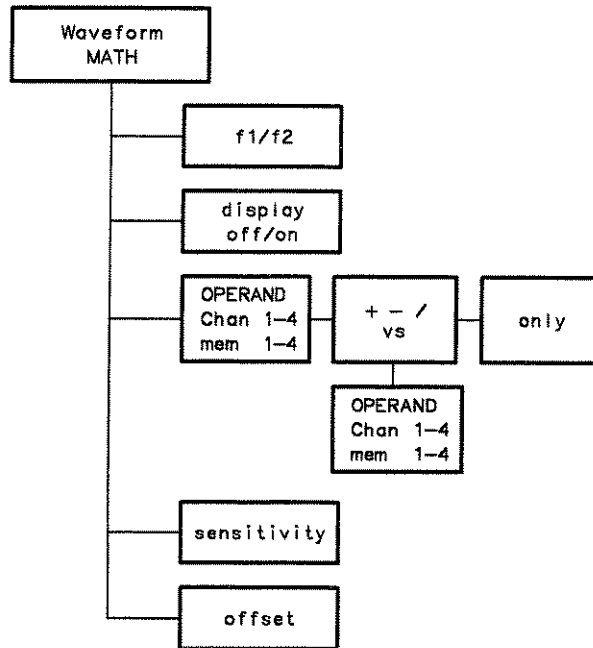

**Figure 3-36. Waveform Math Menu**

The vertical sensitivity and offset are adjusted to position the function for best viewing.

When the function is calculated, it can be used in the following manner:

- displayed
- evaluated with the measurement features
- stored in memory
- output over the HP-IB

---

**Single Sensor  
Input Option**

When Option 001, Single Sensor Input, is installed, channel 4 is not useable. When channel 4 is specified as one of the operands, the advisory "channel is off . . . cannot compute function" is displayed.

---

**Defining a  
Function**

The Waveform Math menu selects and presets any of various operations, sources, and displayed results.

**Function Key**

This key selects either function 1 or function 2 as the label for the operation performed on the selected operands.

**display Key**

The display key turns the selected function on or off. When turned on, the parameters associated with the function are displayed in the function menu fields.

If the function display is turned on, the screen will split with the original waveforms displayed in the top half screen while the functions are displayed in the bottom half screen. Both functions can be on at the same time and are displayed superimposed or in two screens in the bottom half of the display, if multiple screens have been selected.

**Note**

If the display has more windows than are desired, it may be that additional windows have been enabled with the **Display Menu**. Select this menu to turn off the undesired windows.

---

The timebase window is automatically turned off when a function is turned on.

**chan/mem Key**

Press this key to select the first operand of the mathematical operation, or the waveform to be manipulated. The choice can be any displayed channel or any waveform memory that has a waveform stored. Ensure that the source is turned on.

If the operator is *only*, it is the only operand that can be selected.

**Operator Key**

This key selects any of the five operations. Continue pressing the function key until the operation desired is highlighted:

- **plus (+):** The two selected operands are added together in this function. Addition is calculated on a point-by-point basis.
- **minus (-):** The minus operation subtracts the second operand from the first.
- **divide (/):** The first operand is divided by the second.

**Note**

---

When the divisor is very small or zero, the function may be clipped or not displayed. Depending on the available resolution, changing the sensitivity or the offset may not improve the display.

---

- **vs (versus):** The versus function draws an amplitude versus amplitude display of the two selected operands. Versus cannot be stored in a waveform memory because measurements cannot be made on the resultant waveform, however, it can be stored in pixel memory.
- **only:** The only function displays the first operand, adds an offset, and scales it.

**chan/men Key** This key selects the second operand, or the waveform that is manipulated against the first operand. The source choices are any of the displayed channels or any of the memories.

This key is not available if the operator is **only**.

**sensitivity Key** The vertical sensitivity of the function is set with this key. This setting is for ease of viewing and making measurements with the newly developed waveform.

**offset Key** The offset of the function is set with this key.

---

**Note** When a function consists of one or two power operands and the offset is set so the bottom of the function is clipped, an error may occur when a measurement is made on the function.

---

---

## Vertical Scaling Units

Functions are displayed in linear format only. The fundamental measuring units of a function are watts/division (channels 1,4) and volts/division (channels 2,3) in the vertical axis and time/division on the horizontal axis. Where the units of the function cannot be determined, they are shown as UDF, KUDEF, or mUDF, etc., for undefined or user-defined.

## Displaying Functions

The Peak Power Analyzer has several screen variations available to accommodate a 4 channel display, as well as two functions:

- In the single screen mode with a function on, the mathematical results are displayed in the bottom half of the screen while the operands are superimposed in the top half of the screen.

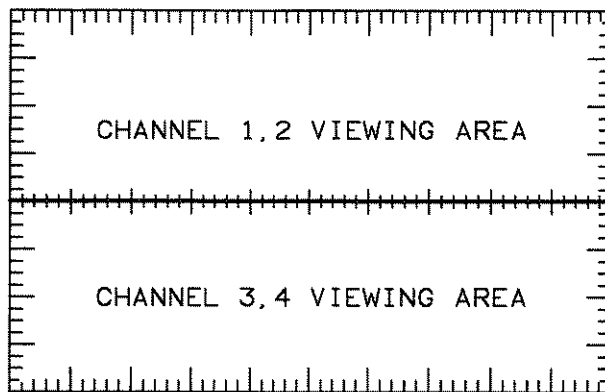

**Figure 3-37. Single Screen w/Function On**

- In the dual screen mode, the functions are again displayed in the bottom half of the screen. However, the dual screens are displayed in the top half.



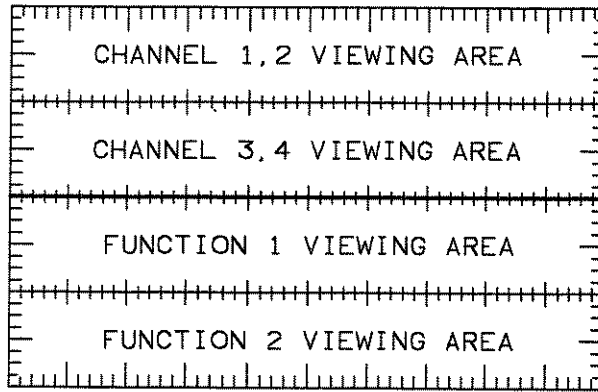

Figure 3-38. Dual Screen w/Function On

- In the quad screen mode, all four screens are displayed in the top half of the display while the function(s) are displayed in the bottom half.

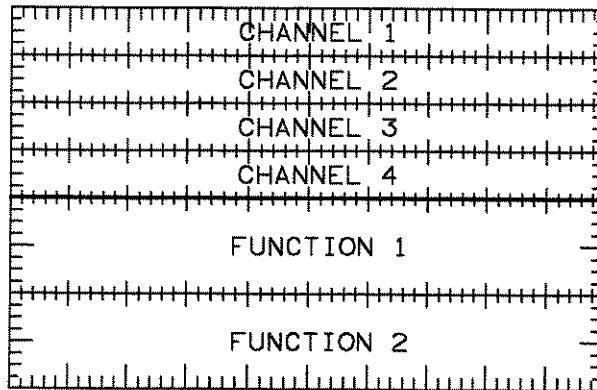

Figure 3-39. Quad Screen w/Function On

## Waveform Math Exercise

In this exercise you will use the Waveform Math menu to subtract one waveform from another.

### Analyzer Setup

The following procedure will assist you in setting up the Peak Power Analyzer for optimal viewing.

- Connect a peak power sensor to channel 1 and the Sensor Check Source.
- Press **RECALL** and then **CLEAR**.

Default settings have been recalled.

The Sensor Check Source has been turned on and set to pulse.
- Press the **DISPLAY** menu key.

Press the **connect dots** key until **on** is highlighted.
- Press **AUTOSCALE**.
- Store the waveform in waveform memory.

Press the **WFORM\MEMORY** menu key.

Press the **source** softkey until **chan 1** is highlighted.

Press **nonvolatile** until **m1** is highlighted.

Press **store**. The waveform is now stored in waveform memory one (m1).

Press **display** until **on** is highlighted.
- Place a 3 dB attenuator pad between the Sensor Check Source and the peak power sensor.

Select the **TRIG** menu, and adjust the trigger **level** for channel 1, if necessary for a stable display.
- Press the **WFORM MATH** menu key.

Press the first softkey until **f1** is highlighted.

Press **display** until **on** is highlighted.

For the first operand, press the third key, and select **m1**.

In the next area select **-**.

For the other operand, press the fifth key, and select **chan 1**.

Now you can see the function of subtracting channel 1 from waveform memory 1 (m1). The vertical sensitivity of the function is shown by the **sensitivity** softkey.

The amplitude of waveform memory 1 is 10 mW, and the amplitude of channel 1 is 3 dB down from 10 mW. The function shows the difference of waveform memory 1 minus channel 1.

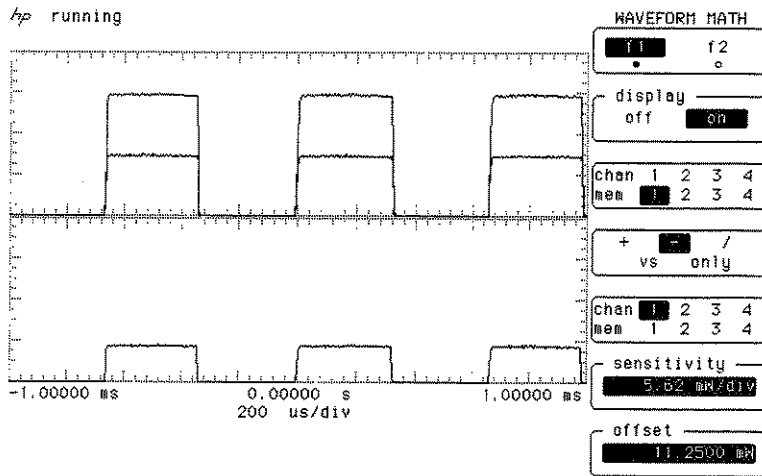

Figure 3-40. Waveform Memory 1 minus Channel 1

**3-100 This Page Intentionally Left Blank**

## Waveform Memory Menu

### Introduction to the Memories

This chapter describes how to select the waveform and pixel memories on the Peak Power Analyzer. The menu consists of two submenus:

- waveform memories m1–m4 used to store one waveform at a time.
- pixel memories p1 and p2 used as a screen store. In this manner, the memories are used as a storage oscilloscope.

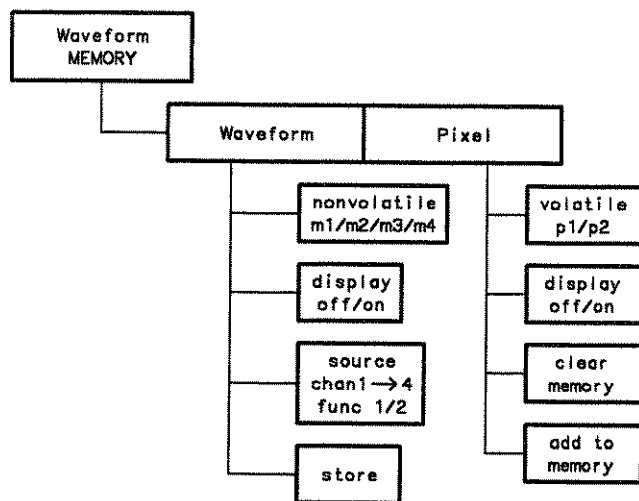

Figure 3-41. Waveform Memory Menu

---

**waveform/pixel  
Key**

This is the selection key used to choose the desired type of memory. The active menu is highlighted. Each memory type, waveform or pixel, has a separate menu. When this key is pressed, the rest of the menu changes.

---

**waveform Menu**

The waveform menu has four available memories, m1, m2, m3, and m4. These memories are nonvolatile and are not cleared during AUTOSCALE, RECALL CLEAR, or recycling power. This permits disconnection of power and transportation of the Peak Power Analyzer without losing the contents of waveform memories.

A waveform memory consists of a single waveform record, including the horizontal and vertical scaling parameters. This allows measurements on stored waveform and function data. Amplitude and time markers can be set on waveforms when they are displayed.

When the Peak Power Analyzer is in the envelope display mode and a waveform store is executed, the min value and max value are stored separately. The min value will be stored in m1 if m1 or m3 are the selected storage locations, or m2 if m2 or m4 are the storage locations. The max values are stored in m3 or m4 respectively. A store message is displayed above the waveform display area informing you of the storage locations of both values.

**nonvolatile Key**

This key selects which memory to use. The selections are nonvolatile memories m1, m2, m3 and m4. When a memory is turned on, the small circle below the label is highlighted.

The waveform memories are record memories that store 2001 points of waveform information in each memory.

**display Key** This toggle key turns the selected memory display on or off.

**source Key** The source key selects the source waveform to be stored. The source alternatives are any channel or either function.

---

**Note** When Option 001, Single Sensor Input, is installed, channel 4 is not useable. When channel 4 is specified as a source, the advisory "no valid data ... nothing stored" is displayed.

---

**store Key** This is the active key in the menu. This key stores the selected waveform in the specified memory. When the key is pressed, an immediate erase of the selected memory and a write to the memory is executed.

---

## pixel Menu

The pixel submenu selects the pixel memories. These memories are very useful when additive memory capabilities are needed. Waveforms can be stored and added to indefinitely.

**volatile Key** This is the memory select key. The alternatives are pixel memory 1 or 2. The pixel memories are complete pixel saves of the waveform area (excluding the graticule and markers) in volatile memory. The waveform display area is 256 X 451 pixels.

In pixel memory the entire screen is saved. Therefore, data is mapped directly onto the display and displayed in halfbright. There are no measurement capabilities on pixel memories.

Pixel memories are additive. Only unlit pixels are effected by subsequently adding to memory. When all

pixels are full, adding to memory will merely overwrite existing data.

**display Key**

This toggle key turns the selected pixel memories on or off.

**clear memory Key**

This key purges all data from the selected pixel memory.

**add to memory Key**

By pressing this key, the currently displayed waveforms are added to the specified pixel memory.

---

**Waveform Memory Exercise**

Using the Sensor Check Source, this exercise demonstrates how to store a waveform, change the vertical sensitivity setting, and recall the stored waveform to be compared with the current display.

**Analyzer Setup**

This procedure assists you in setting up the Peak Power Analyzer for optimal viewing.

- Connect the peak power sensor to channel 1 and the Sensor Check Source.

**Note**

Adapters (HP Part Number 1250-1744, for the HP 84813A Peak Power Sensor and HP Part Number 11903D, for the HP 84814A Peak Power Sensor) will be needed. These adapters are not supplied with the Analyzer.

- 
- Press **RECALL** and then **CLEAR**.
    - Default settings were recalled.
    - The Sensor Check Source was turned on and set to pulse.
  - Select the **DISPLAY** menu key.



Press the **connect dots** key until **on** is highlighted.

- Press **AUTOSCALE**.
- Select the **WFORM\MEMORY** menu key.
- Press the top softkey until **waveform** is highlighted.
- Press the **nonvolatile** softkey until **m3** is highlighted.
- Press the **source** softkey until **chan 1** is highlighted.
- Press the **store** softkey.

The currently displayed waveform is in nonvolatile memory m3. The remainder of this exercise demonstrates how to recall the stored waveform.

- Press the **display** softkey to turn on the **m3** display.
- Press the **CHAN\VERT** menu key, change the **scale** of channel 1.

This moves the current display so the stored waveform can be viewed. The display should look similar to the following figure.

# Waveform Memory Menu

HP 8990A

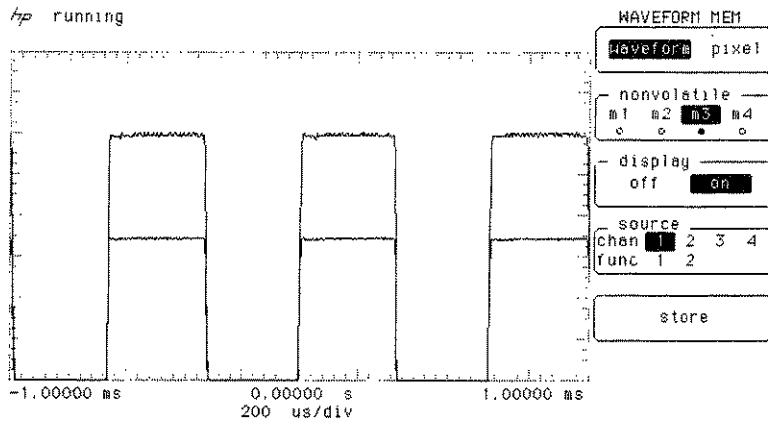

fine

Figure 3-42. Displayed Memory

## Define Measure Menu

---

### Introduction to Measurements

This chapter contains a description of how to use the measurement menu. This is a very powerful and encompassing feature. By pressing the front panel menu key **Define Meas** you can access the entire measurement function.

#### Note

The minimum triggerable pulse width for channels 2 and 3 is 7 ns. Trigger quality for channels 1 and 4 degrades for pulses narrower than 500 ns.

When making a measurement, manual calibration of the Peak Power Analyzer and the peak power sensor is not required. The sensor contains an EEPROM with the necessary calibration data to characterize the sensor. The sensor supplies the Peak Power Analyzer with the calibration data when connected to Analyzer.

Periodically, the Analyzer measures the temperature of the sensor and adjusts the calibration data accordingly to maintain accurate measurements. Automatic adjustment of calibration data is specified over a sensor temperature range of 0° to 55°C.

For maximum accuracy, calibration of the Peak Power Analyzer should be performed only if the temperature of the Peak Power Analyzer (not the sensor) has changed significantly. The accuracy error for every degree Celsius deviation from the last calibration is 0.15%/deg. C (0.006 dB/deg. C). The vertical calibration procedure which performs this calibration is explained in the Utility Menu section of this manual.

---

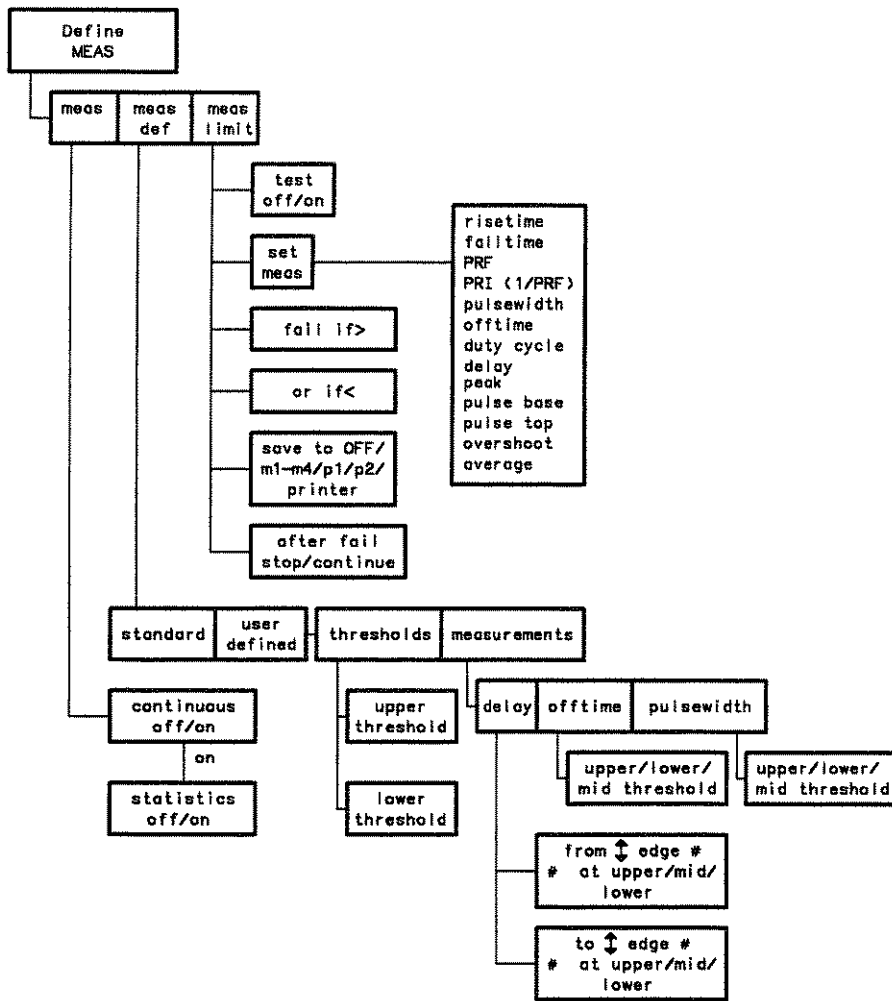

Figure 3-43. Define Measure Menu

The first menu allows you to set the dynamic controls for your measurement. The second allows you to set user-defined parameters for your measurements. And the third allows you to set up the measurement comparison test.

## Measurement Selection

It is very simple to make measurements from the keyboard. Most keys in the numeric keypad section have a secondary function. Above those keys, the measurement selection is printed in blue. There are thirteen measurements which can be made from the keypad:

- Risetime
- Falltime
- PRF (Pulse Repetition Frequency)
- PRI (Pulse Repetition Interval)
- Pulse Width
- Offtime (Pulse Offtime)
- Duty Cycle
- Delay
- Top (Pulse Top)
- Base (Pulse Base)
- Overshoot
- Average (Average Power Measurement)
- Peak (Peak Power Measurement)

### Note

The Peak Power Analyzer isn't able to make automatic overshoot measurements when overshoot is greater than 50%. It may be necessary to use the markers to make the measurement.

When Option 001, Single Sensor Input, is installed, channel 4 is not useable. If an attempt is made to specify channel 4 as the source for a measurement, the advisory "channel is off ... measurement is aborted" is displayed.

To make an immediate measurement of the displayed waveform, perform the following keystrokes:

- Press the blue (Shift) key on the numeric keypad to access the secondary keys.
- Press the key that corresponds to the measurement.
- Rotate the knob to select the measurement source (channel number, c#; memory number, m#; or function number, f#). The choice is displayed below the waveform display area.
- Press the appropriate number to select the source, channels 1-4, memories 1-4, or functions 1-2.

To make a selected measurement on a waveform source, it must be turned on. Upon selection of the measurement, the time and amplitude markers are placed on the waveform to show where the measurement was made, if continuous measurements are off.

To clear measurements, press Shift (blue key) CLR MEAS.

For complete details of the measurement definitions and algorithms, see Appendix A, "Algorithms."

---

**meas/meas**  
**def/meas limit Key**

This key is the primary sub-menu function key. Press to select one of the available sub-menus. This field is always the top selection so other submenus can be selected at any time.

---

**Measure  
Sub-menu**

The measure submenu is the default condition. The continuous and statistics options can also be accessed.

**continuous Key**

If this option is turned on when a measurement selection is made, the displayed measurement is updated periodically. All subsequent measurements are continuously updated as they are selected.

When **continuous** is off, the measurement is made once and the amplitude and time markers are placed on the waveform showing where the measurement was made.

**statistics Key**

The continuous function must be on before the statistics key is available. When **continuous** is on, statistics will display the *min value*, *max value*, *average value*, and *current value* of up to three measurements.

---

**Measure Define  
Sub-menu**

The Measure Define sub-menu selects measurement standards assigned by the user. This function gives the option of making measurements based on signal width, delay settings, or threshold parameters.

**standard/user defined  
Key**

If **standard** is selected, no other choices are available and the Peak Power Analyzer will make measurements based on the IEEE standards for the particular measurement.

If, however, **user defined** is selected, two sets of test conditions are available to define the measurements.

**thresholds  
measurements Key**

This key sets the vertical test conditions, percentage ratios, independent of the horizontal test conditions, edge, slope, and count. Both sets of test conditions must be set to define the measurement.

The **thresholds** submenu sets the vertical test conditions of percentage ratio from -25% to 125%.

**Note**

The upper and lower thresholds must be set to levels that will fall on the displayed waveform. If either threshold is not on the waveform, the measurement results will be the message "not found."

Threshold settings apply to all user defined front panel measurements.

This feature is useful when measuring for excessive overshoot or ringing. The user can define the measurements, test for specific pass/fail criteria from the front panel, or set the Peak Power Analyzer in the limit test and allow the Peak Power Analyzer to report without supervision.

**Note**

If the user defined upper and lower thresholds are placed too close together, it is possible the Peak Power Analyzer will not be able to determine the mid-point. The message "not found" will be displayed in the measurement factors area.

**Measurements** defines more parameters, the horizontal test conditions, for three specific front panel keypad measurements:

- Delay
- offtime
- pulsewidth

When any one of the three measurements is selected, the measurement is made on the selected edge count, slope,



and transition point. The Peak Power Analyzer starts counting edges from the left edge of the screen, not at the reference point. The selected edge must be displayed. If the edge is not displayed, the message "not found" is displayed in the measurement results area below the screen.

Measurement delay, not to be confused with timebase delay (see 'Timebase Menu') is useful when measuring source-to-source delays or measuring time separation on the same source or a different source. The front panel delay measurement can be redefined by edge slope, edge count (from 1 to 100), and what part of the transition edge (upper, lower, mid) is used as a reference point.

- When setting edge count fields, it is handy to press the fine key. In the coarse mode, the Peak Power Analyzer increments/decrements by tens (1, 11, 21, ... 100). In the fine mode, the increment/decrement sequence is in 1's.

When the delay measurement is selected from the front panel, the sources (c#, f#, m#) and the source number must be selected next.

Pulsewidth chooses only the point on the waveform transition (upper, lower, mid) to measure when making the positive width of a displayed waveform.

Offtime chooses only the point on the waveform transition (upper, lower, mid) to measure when making the negative width of a displayed waveform.

---

**Measure Limit  
Sub-menu**

The Peak Power Analyzer can run limit tests on up to three measurements. The menu presets certain conditions and stores any failure data for evaluation at a later time. Set your limit test while in this menu and select the measurement from the front panel.

When a test is running, statistical data is displayed describing the test:

- current measurement
- minimum value
- maximum value
- average value

Failure data, as well as information regarding memory and save data is displayed.

---

**Note**

At least one measurement and up to three measurements must be selected from the keypad. The limit test will be run on front panel measurements.

---

**test Key**

This toggle switch turns the test routine on or off. When the test is turned on, the Peak Power Analyzer runs in the test mode on the most current measurements that have been selected.

**set Key**

This key selects the measurement. There are thirteen measurements available; these are the same measurements that are available on the numeric keypad.

- Press the function key to highlight the field and rotate the knob to select the desired measurement.

- fail if > Key** This field sets the upper failure threshold. The range on this field is dependent upon the units of the desired measurement.
- or if < Key** This key sets the lower threshold of the failure parameters.
- save to Key** The data associated with the failure can be saved to memories or to a hardcopy device. The channel that is saved is selected in the "Waveform Memory" menu.
- In the case of saving to nonvolatile memory, one memory may be selected. If multiple failures occur, only the last failure data will be saved, because the most current data will overwrite the memory contents.
  - If the data is saved to pixel memory, an accumulated save occurs. No measurements may be made on the pixel data.
  - A save to a printer immediately sends the data to the peripheral device.
  - The **save to** key can be turned off and no save will be performed.
- after fail Key** The test can be stopped after a failure occurs, or the test can be set to continue.

**3-116 This Page Intentionally Left Blank**

## Utility Menu

---

### Introduction to the Utilities

The Utility Menu accesses the calibration and service functions, as well as sets up the HP-IB interface. The submenus include selftest, calibration, service, and an instrument status listing.

These submenus are part of the Utility Menu:

- HP-IB menu
- show status
- selftest menu
- probe cal menu
- instr cal menu
- service menu

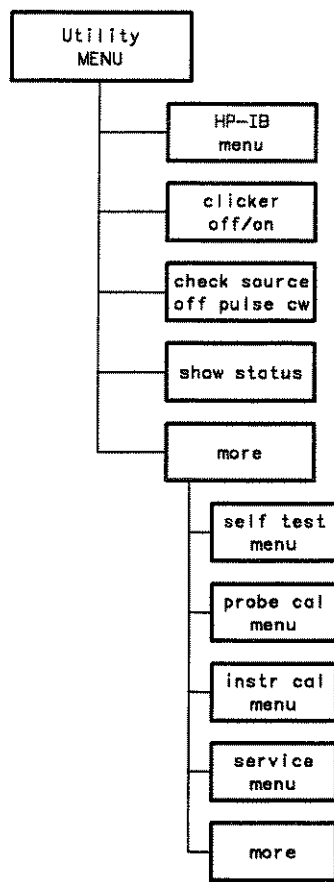

Figure 3-44. Utility Menu

**Note**

The following submenus can be unexpectedly overwritten with messages or data when an HP-IB command initiates a new data acquisition cycle. These menus should be avoided while controlling the Peak Power Analyzer over the bus. The Root Level Command MENU can be used to switch from one of these menus.

- Selftest Menu
- Probe Cal Menu
- Instrument Cal Menu
- Service Menu
- Show Status Menu

---

**HP-IB Menu**

The HP-IB submenu is used to set up the Peak Power Analyzer so it can talk to peripheral devices. This interface includes two primary settings:

- talk only mode
- addressed mode

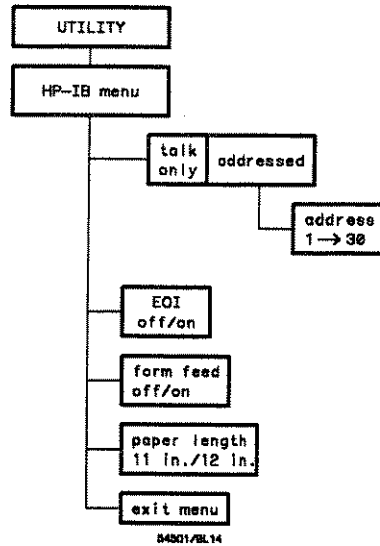

Figure 3-45. HP-IB Menu

**talk only mode**

Set the Peak Power Analyzer to **talk only** when performing a hardcopy of the display without intervention from an external controller. The attached printer must be set to the **listen only** or **listen always** mode.

**addressed mode**

This mode allows a controlling device to selectively address the Peak Power Analyzer for talking or listening. The address of the Peak Power Analyzer can be selected while the instrument is in the addressed mode.

The range of available addresses is 0–30

**EOI Key**

The EOI (End or Identify) key toggles this function on or off. EOI is a line on the HP-IB asserted with the last data byte of a message.

If this function is on, EOI is asserted by the Peak Power Analyzer on the last byte of each message sent. If it is off, EOI is not asserted.



This function only affects messages sent from the Peak Power Analyzer. The HP-IB accepts any of the legal IEEE 488.2 message terminators regardless of the setting of this function.

**Note**

IEEE 488.2 requires that EOI is asserted. Therefore, with EOI off, the Peak Power Analyzer will send messages that do not follow IEEE 488.2 rules concerning EOI. EOI should only be turned off if the controller does not deal with EOI appropriately.

**form feed Key**

If the form feed option is on, the printer performs a formfeed at the end of the hardcopy. If formfeed is off, the page is scrolled up four lines when the hardcopy is complete.

**paper length Key**

Select between 11 inch or 12 inch page lengths for auto form feed. This is used to set the 11 inch page, the U.S. standard, or the 12 inch page, U.K. and European standard.

**exit menu Key**

Pressing this key returns to the Utility menu.

---

**clicker Key**

The clicker key turns on the clicker function. When the clicker is turned on, an audible click is heard each time a key is pressed. The selections are either on or off.

---

**check source Key**

This key turns the front panel Sensor Check Source on or off. The Sensor Check Source is used during delay calibration for channels 1 and 4 and to verify operation of the peak power sensor. The signal output is a 1 GHz signal, either pulsed or CW. If pulsed is selected, the signal is pulsed at a 1.5 kHz rate.

**Note**

---

Settling time for the Sensor Check Source is two to three seconds.

---

The Sensor Check Source is turned on or off by pressing the key until the desired function is highlighted.

---

**show status menu**

The show status key displays the following instrument status information:

- Instrument model number
- Firmware revision
- Whether the baseband board for channel 1 is present.
- Whether the baseband board for channel 4 is present.
- Whether the sensor check source is present.
- The model number of the sensor connected to channel 1.
- The model number of the sensor connected to channel 4.
- The temperature of the sensor for channel 1.
- The temperature of the sensor for channel 4.
- The thermistor resistance of the sensor for channel 1.
- The thermistor resistance of the sensor for channel 4.

**update Key**

Instrument status information is not updated and displayed automatically. When any of the parameters change, there are two ways to update the information:

- By pressing the **update** key.
- When the show status menu is selected.

The update key may be pressed at any time to display new status information.

---

**more Key**

This key accesses the second utility menu.

---

**selftest menu**

The Peak Power Analyzer is designed to perform internal diagnostics. This selftest submenu tests the Peak Power Analyzer to determine potential calibration errors.

**Note**

If the Peak Power Analyzer is uncalibrated due to being serviced or an internal failure, the selftests may fail. If the selftests fail, perform the calibrations listed under “The Peak Power Analyzer has been Serviced” portion of the “Order of Calibrations” section in this chapter. Run the selftests again. If the selftests still fail, refer to the Peak Power Analyzer Service manual.

Before performing any self test, do a key down power-up. This resets many critical parameters to known values and assures that erroneous test failures do not occur. A key down power-up is performed by holding down any key and turning the Peak Power Analyzer off then back on.

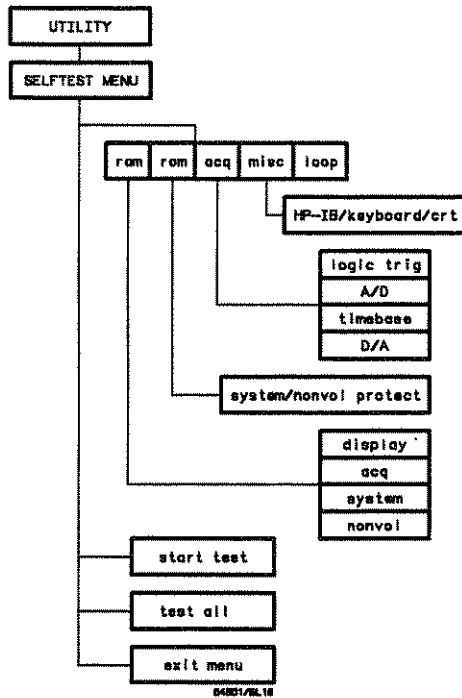

Figure 3-46. Selftest Menu

The Peak Power Analyzer self-diagnostics and selftests are designed to run operational tests on the following:

- ram
- rom
- acquisition
- miscellaneous

PASSED System RAM

PASSED Non-Volatile RAM

PASSED Display RAM

PASSED Protected Non-Volatile RAM

PASSED System ROM

PASSED Acquisition RAM

PASSED Logic Trigger

PASSED Timebase

PASSED D/A Converter

PASSED HPIB

PASSED A/D Converter

to run selftest, disconnect all inputs

SELFTEST MENU

rom rom acq  
 misc loop

display acq  
 system nonvol

start test

test all

exit menu

54501/NF75

Figure 3-47. Results of Selftest

**ram Test** The ram test is a multiple selection field. The options are:

- display
- acquisition
- system
- unprotected nonvolatile memory

**rom Test** Two rom tests are available:

- system
- protected nonvolatile memory

**acquisition Test** Four acquisition tests are available:

- logic trigger
- A/D
- timebase
- D/A

**miscellaneous Tests** Three miscellaneous tests are available:

- HP-IB
- keyboard
- crt

**loop Test** The loop test is a function designed for use by qualified service personnel. It is unnecessary to use this function for normal Analyzer operation. When a self-test loop has been initiated, it runs until stopped by pressing and holding any key.

**start test Key** Pressing this key begins the selected test.

**test all Key** Pressing this key causes all the self tests to be run.

**exit menu Key** Pressing this key returns to the Utility menu.

## Order of Calibrations

There are four situations that require the Peak Power Analyzer to be calibrated. Each situation requires that the calibration procedure be performed in a specific order. The situations are listed below:

- The Peak Power Analyzer needs calibrating to meet its specified accuracy.
- The Peak Power Analyzer has been serviced.
- A probe cal is required.
- A time null is required.

## Calibrating to meet Specified Accuracy

At certain times the Peak Power Analyzer may require calibrating to meet its specified accuracy. The conditions that require calibrating are listed in the “instr cal menu” section of this chapter. The calibrations must be performed in the order listed:

- Vertical Cal
- Delay Cal

The Vertical Cal and Delay Cal procedures are described in the “instr cal menu” section of this chapter.

## The Peak Power Analyzer has been Serviced

If the Peak Power Analyzer has been serviced, for example, the ROMs have been replaced, an assembly has been replaced, or the instrument has been repaired, the following calibrations need to be performed in the order listed:

- Default Cal
- Vertical Cal on channels 2 and 3
- Logic Trigger Delay Cal
- Vertical Cal on all channels (For Option 001, perform the Vertical Cal on channels 1, 2, and 3 only!)

- Delay Cal on all channels (For Option 001, do *not* perform the Delay Cal on channel 4!)

Default Cal and Logic Trigger Delay Cal are described in the Service Manual and where the “service menu” is described near the end of this chapter. Vertical Cal and Delay Cal are described in the “instr cal menu” section of this chapter.

**Probe Cal** This calibration applies to channels 2 and 3. The calibration procedure is described in the “probe cal Menu” section of this chapter.

**Time Null** Time null sets the timing difference between channels. Using time null is described in the “time null submenu” section of this chapter.

---

### probe cal Menu

Two probe calibration procedures are available in the probe cal menu:

- attenuation
- time null



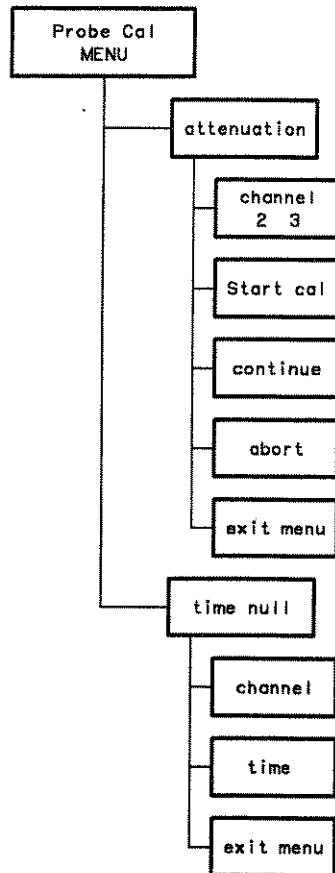

Figure 3-48. Probe Cal Menu

### attenuation submenu

The attenuation submenu is only used with channels 2 and 3. It is used to calibrate gain at the tip of a probe. Channel gain can be corrected through probe attenuation down to 0.9 attenuation.

- Below 0.9 the error message *Attenuation less than 1, see manual for action* is displayed. The corrective action is to recalibrate the Peak Power Analyzer. Perform vertical cal under the “instr cal” menu.

If the probe is not connected to the DC CAL OUTPUT on the rear panel or the probe attenuation exceeds approximately 250, the error message *Attenuation too high or bad connection* is displayed. The corrective action is to check the connections and recalibrate. If recalibration is unsuccessful, refer to the Peak Power Analyzer Service Manual.

- If the probe attenuation calibration is successful, the displayed message is *Probe Attenuation = n.nnnnn*. This value has been entered into your channel probe setting.

- channel Key** Pressing this key selects a channel to calibrate. By continually pressing the key, the fields are incremented by channel.
- start cal Key** When the channel to be calibrated has been selected, press **start cal**. The advisory appears at the bottom of the waveform display area *Connect the DC Cal rear panel BNC to the probe of channel n, then press continue*. Pressing this key prompts the user with setup requirements.
- continue Key** Press this key when all setup requirements have been satisfied. The actual calibration process begins.
- abort Key** This is the only active front panel key during the calibration process. If you press this key, the calibration process is terminated with the previous calibration factors intact.

**exit menu Key** Pressing this key returns to the Utility menu.

**time null submenu** Time null sets the timing of all channels to correspond to each other. This eliminates any time discrepancies between channels and guarantees that channel to channel skew variations are non-existent. Time null is useful for **MANUALLY** adjusting any differences in the time domain (for example, cable length). Time null should be run any time a sensor with a different length cable is used. For information about eliminating internal skew, refer to the "instr cal memu" and delay cal.

**channel Key** This selection key allows you to select the channels to be set to each other. All channels are set to channel 1, therefore, the selections are as follows:

- 1 to 2
- 1 to 3
- 1 to 4

This field is never displayed in fullbright designating it as an active field; however, it is always active. Pressing this key changes the selection. Each time the key is pressed, the selection is incremented.

**time Key** This is an unlabeled field. The time null between the two channels can be set using either of the entry devices. The range is  $\pm 70$  ns.

**exit menu Key** Pressing this key returns to the Utility menu.

**instr cal menu**

The instr cal menu consists of two calibrations:

- vertical cal
- delay cal



**Figure 3-49. Instrument Cal Options**

Vertical cal calibrates the vertical scale of the Peak Power Analyzer. The calibration only needs to be done under a few conditions:

- The ambient temperature of the Peak Power Analyzer has changed since the last time a vertical cal was performed.

**Note**

---

For maximum accuracy, calibration of the Peak Power Analyzer should be performed only if the temperature of the Peak Power Analyzer (not the sensor) has changed significantly. The accuracy error for every degree Celsius deviation from the last calibration is 0.15%/deg. C (0.006 dB/deg. C). The temperature of the Peak Power Analyzer also has an effect on the trigger level accuracy of channels 1 and 4.

---

- The Peak Power Analyzer was repaired.
  - The ROMs have been replaced.
- 

**Note**

If the Peak Power Analyzer is repaired or the ROMs are replaced, additional calibrations, other than those listed in this section, need to be performed. Refer to the "Order of Calibrations" section described earlier in this chapter.

---

Delay cal sets the absolute time skew values from the physical trigger event to the trace timing display of the trigger event. Channel 1 is used as the reference point. For the channel being calibrated, the trigger reference point is set to the center of the screen and trigger delay is set to zero.

---

**Note**

Before the Peak Power Analyzer can be calibrated the CALIBRATION toggle switch on the rear panel must be set to UNPROTECTED. When the software calibrations are complete, reset the CALIBRATION toggle switch on the rear panel to PROTECTED.

---

**cal select Key** This field selects which of the calibration processes to perform. Press the cal select key and the highlighted window increments through 0-1. The active field in the display changes to correspond with the selection.

**channel Key** The channel key selects the channel to calibrate.

**start cal Key** When the channel to calibrate is selected, and the specific cal routine is selected, press the **start cal** key and follow the displayed instructions.

The following information will make performing the calibrations easier:

#### Vertical Cal

1. Perform the calibration after a minimum of a one hour warm-up after power on. Not allowing a one hour warm-up will not cause the instrument to fail, but specified accuracy is not guaranteed.
2. When calibrating channels 1 or 4, there must not be any RF present at the sensor input. Either disconnect the sensor from the Peak Power Analyzer, or ensure that any signal at the sensor input is at most -60 dBm; the Peak Power Analyzer has the capability of detecting very small (nW) signals. If the sensor remains connected, ensure that the sensor is not placed in a strong electromagnetic field (for example, against a CRT).
3. Calibration of all four channels takes a number of minutes. Calibration of an individual channel requires less time.
4. As the calibration is performed, PASSED, FAILED, or ABORTED is displayed. If the **abort** key is pressed, aborted is displayed; the old calibration data is kept if the calibration is aborted.

5. If the calibration failed, write down the "1s" and "0s" that are displayed. The sequence is useful to the service personnel.

#### Delay Cal

---

#### Note

Use the BNC cable (HP part number 10503A) that is supplied with the Peak Power Analyzer to make the connection from the rear panel AC CAL output. Do not use a BNC tee with the cable. If the supplied cable is not used, the accuracy of the time skew can not be guaranteed. The cable is 1.5 metres and has a delay of 5 ns  $\pm 10\%$ .

For specified accuracy, the sensor(s) used in delay cal should be the sensor(s) used for the measurement. However, if the greatest time accuracy is not needed, any sensor **with the same cable length** (1.5 metres versus 6 metres) is generally close enough.

---

The following information is especially useful for timebases faster than 50 ns/division. During the delay cal process, cabling which will be connected to channel 2 or 3 during a measurement can be calibrated out. Simply include the cabling between the cable supplied with the Peak Power Analyzer and the channel 2 or 3 input during the delay calibration.

#### continue Key

When all of the setup requirements are satisfied, press the **continue** key and the actual calibration process begins.

**abort Key** This is the only active front panel key during the calibration process. Pressing this key terminates the calibration process leaving the previous calibration factors intact. Once the abort key is pressed, the calibration may continue for a few moments before it finally aborts.

**exit menu Key** This key returns to the Utility menu.

**If Calibration Fails** If vertical cal fails, verify the following:

- Is the setup correct?
- For channels 1 and 4, was the peak power sensor disconnected from the Peak Power Analyzer, or is the signal at the peak power sensor at most  $-60$  dBm.
- For channels 2 and 3, was the connection made to the rear panel DC CAL connector?

If the items mentioned have been checked out, refer to the Peak Power Analyzer Service Manual.

If delay cal fails, verify the following:

- Was vertical cal done recently?
- Was the BNC cable (HP 10503A) supplied with the Peak Power Analyzer used for the calibration?
- Was the BNC cable connected to the rear panel AC CAL connector

If the items mentioned have been checked out, refer to the Peak Power Analyzer Service Manual.



---

**service menu**

The service menu is used primarily for software settings and hardware adjustments. These are explained in the service manual and are to be used only by qualified service personnel.

**Default Cal**

One calibration needed for the software calibration of the Peak Power Analyzer is in the service menu. When the ROMs have been replaced or the instrument has been serviced, the default calibration factors must be set before continuing with the instr cal menu. To set the default cal factors, perform the following steps:

**Note**

The default calibration returns the following calibration factors to default settings: Logic Trigger Delay Cal, Vertical Cal, Delay Cal, Probe Cal, and Time Null Cal. **If you run the default calibration, you must continue with a full instrument calibration.** Refer to the "Peak Power Analyzer has been Serviced" portion of the "Order of Calibrations" section discussed earlier in this chapter.

- 
- Select the service menu.
  - Press the **cal select** key until 3 (default cal) is displayed in the window and default cal is highlighted.
  - Press **start cal** and **continue** when the instructions are displayed.

**Logic Trigger Delay  
Cal**

When a default cal has been performed, it is necessary to run the logic trigger delay cal. The steps used for selecting this calibration are the same used to select the default calibration.

- Select the service menu.

## Utility Menu

HP 8990A

- Press the **cal select** key until 0 (logic trigger delay cal) is displayed in the window and logic.trigger delay cal is highlighted.
- Press **start cal** and **continue** when the instructions are displayed.

---

## more Key

This key accesses the first level utility menu.

## **Performance Tests**

---

### **Introduction**

The procedures in this section test the electrical performance of the instrument using the warranted specifications as performance standards. These tests are suitable for incoming inspection and necessary for calibration. All tests can be performed without access to the interior of the instrument.

### **Equipment Required**

Equipment required for the performance tests is listed in table 4-1, Recommended Test Equipment. Unless noted otherwise, any equipment that satisfies the critical specifications given in the table may be substituted.

### **Performance Test Record**

Results of the performance tests may be recorded in the Performance Test Record. The table is located at the end of this chapter. The Performance Test Record lists all of the tested specifications and their acceptable limits. Results recorded at incoming inspection can be used for comparison in periodic maintenance and troubleshooting, and after repairs or adjustments.

### **Calibration Cycle**

This instrument requires periodic verification of performance. Under normal use and environmental conditions, the instrument should be calibrated annually. Normal use is defined to be about 2000 hours of use per year.

**Performance Test  
Procedures**

These tests are designed to verify published instrument specifications. Perform the tests in the order given, and record the data in the Performance Test Record.

In order to consider a performance test valid, the following is assumed:

- The Peak Power Analyzer has had a **one hour warm-up period** before the tests are performed.
- The person who performs the test understands how to use the specified test equipment.
- The tests are performed under normal operating conditions as stated in the specification table.
- The person who performs the test supplies whatever cables, connectors, and adapters are necessary.
- For certain tests, measurement limits are calculated using specific equipment. As noted in the tests, these limits must be recalculated if equipment other than that specified is used.
- A user calibration of the peak power measurement system is run prior to performance of these tests.

## Checking Risetime/Falltime

### Specification

Electrical Characteristics	Performance Limits	Conditions
Channels 1 & 4 Risetime/ Falltime	$< 5 \text{ ns}^1$ $< 6 \text{ ns}^1$ $< 1 \mu\text{s}$ $< 80 \mu\text{s}$	10%—90%/ 90%—10% 0 to +20 dBm -16 to 0 dBm -26 to -16 dBm -32 to -26 dBm
Channels 2 & 3 Risetime/ Falltime	$< 5 \text{ ns}$	

<sup>1</sup> The optional 20 foot long peak power sensor cable degrades the specified risetime to 10 ns. Specification for the HP 84815A is  $< 45 \text{ ns}$ .

### Description

The risetime for RF channels 1 and 4 is measured using a fast risetime pulse which is mixed with a 2 GHz local oscillator. The resulting pulsed signal drives the peak power sensor. The amplitude of the pulsed waveform is varied by changing the output power level of the local oscillator. The risetime of each power range of the Peak Power Analyzer is checked by making automatic risetime measurements.

The risetime of video channels 2 and 3 is verified using a fast risetime pulse which is input directly to the Peak Power Analyzer.

**Note**

In the following procedure, the risetime/falltime specification is tested. Thus, if preferred, wherever the term “risetime” is used, the term “falltime” can be substituted in order to measure falltime.

**Equipment**

Pulse Generator .....	HP 8131A
Signal Generator.....	HP 8657B
Mixer .....	Watkins Johnson M85C
Peak Power Sensor.....	HP 84812A, 84813A, 84814A, or 84815A

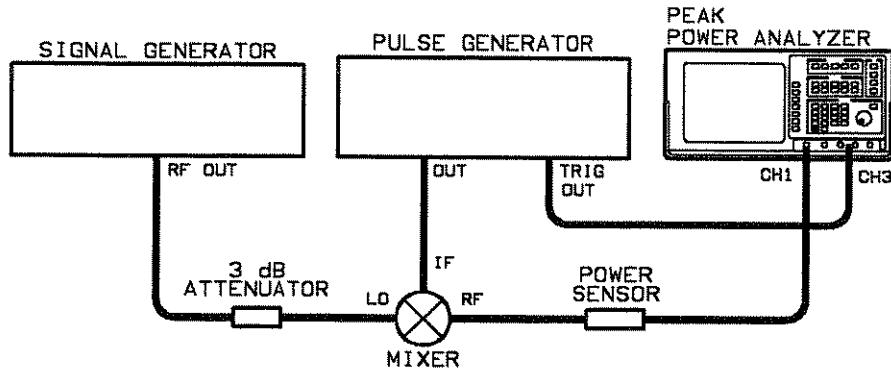

Figure 4-1. Checking Channel 1 and Channel 4 Risetime Equipment Setup

**Procedure**

**To set up the test equipment**

1. Set the signal generator as follows:
  - a. Mode: CW
  - b. Output Level: 0 dBm
  - c. Frequency: 2 GHz
2. Set the pulse generator as follows:
  - a. Mode: Continuous pulse stream
  - b. Period: 1 ms

- c. Risetime: < 500 ps
  - d. Amplitude: 0.5 volt
  - e. Duty Cycle: 50%
3. Connect the equipment as shown in Figure 4-1.

**Table 4-1.**  
**Risetime/Falltime Settings and**  
**Expected Measurement Results**

Vertical Scale Setting	Input Signal as Measured	Number of Averages	Risetime/Falltime Specification
500 $\mu$ W/div	2 mW (3 dBm)	128	<5 ns <sup>1</sup>
5 $\mu$ W/div	25 $\mu$ W (-16 dBm)	128	<6 ns <sup>1</sup>
500 nW/div	2.5 $\mu$ W (-26 dBm)	128	<1 $\mu$ s
100 nW/div	630 nW (-32 dBm)	128	<80 $\mu$ s

<sup>1</sup> Specification for the HP 84815A is <45 ns.

#### To set up the Peak Power Analyzer

1. Press **AUTOSCALE** on the Peak Power Analyzer.
2. Select the **CHAN/VERT** menu and set the following parameters using the displayed menu:
  - a. Select (highlight) channel 3 with the top function key.
  - b. Turn the channel **off** with the second function.
3. Select the **CARRIER FREQ** menu, and set the following parameter using the displayed menu:
  - a. Highlight **ch1 $\neq$ ch4** with the top function key.
  - b. Select **ch1** with the second function key.
  - c. Enter 2 GHz with the knob or the keypad. If the keypad is used, terminate the entry with the **GHz** key on the right side of the keypad.

4. Select the **DISPLAY** menu, and set the following parameters using the displayed menu:
  - a. Highlight (select) **norm** with the first function key.
  - b. Highlight **1** with the **# of screens** function key.
  - c. Highlight **grid** with the fifth function key.
  - d. Highlight **on** with the **connect dots** function key.
5. Select the **CHAN/VERT** menu, and set the following parameters using the displayed menu:
  - a. Highlight **1** with the top function key.
  - b. Highlight **low** with the **bandwidth** function key.

**To verify the 5 ns risetime**

1. Make an average power measurement using the following procedure:
  - a. Press the **BLUE** key, and then the **AVG** (**8**) key.
  - b. Press **1** when **C#** appears at the bottom of the display. If **C#** is not displayed, use the knob to display **C#**.
2. Select the **CHAN/VERT** menu, and set the following parameter using the displayed menu:
  - a. Select the **scale** function key.
  - b. Using the knob or the keypad, set the scale to 500  $\mu\text{W}$ /division. If the keypad is used, terminate the entry with the  $\mu\text{W}$  key on the right side of the keypad.
3. Adjust the signal generator output power to 2 mW as shown in Table 4-2 under "Input Signal as Measured."
4. Select the **DISPLAY** menu, and set the following parameters using the displayed menu:



- a. Highlight (select) **avg** with the first function key.
  - b. Set the number of averages to **128** using the second function key. Use the knob or the keypad to set the number of averages. If the keypad is used, terminate the entry with any of the suffix keys on the right side of the keypad.
5. Fine tune the signal generator power level so the average power at the bottom of the Peak Power Analyzer display reads 2 mW.
  6. Adjust the vertical scale (CHAN/VERT menu) of channel 1 so the waveform spans at least three divisions.
  7. Select the **DISPLAY** menu, and with the first function key, set the display mode to **norm**.
  8. Select the **CHAN/VERT** menu, and set the **bandwidth** to **high**. Adjust the vertical scale to span three divisions, if necessary.
  9. Select the **TIMEBASE** menu, and set the following parameters using the displayed menu:
    - a. Set the timebase to display one rising edge across two horizontal divisions. Change the timebase with the knob or the keypad.
    - b. Adjust the delay to move the waveform, if necessary.
  10. Select the **DISPLAY** menu, and with the first function key, set the display mode to **avg**. The number of averages should still be set to **128**. Give the display time to settle once **avg** is selected.
  11. Adjust the timebase if the rising edge of the pulse no longer spans two divisions horizontally.
  12. Make an automatic risetime measurement using the following steps:

- a. Press the **BLUE** key, and then the **RISETIME** (4) key.
  - b. When #C appears at the bottom of the display, press (1).
13. Read the risetime at the bottom of the Peak Power Analyzer display. The risetime should be as shown in Table 4-2.

#### To verify all Channel 1 and 4 risetimes

1. Repeat the section "To verify the 5 ns risetime" for the other power levels in Table 4-1.
2. The results of this test may be entered in the Performance Test Record at the end of this chapter.
3. Disconnect the peak power sensor from channel 1 and connect it to channel 4.
4. Disconnect the TRIG signal from channel 3 and connect it to channel 2.
5. Repeat the entire procedure to verify the risetime specifications for channel 4.

#### To verify the risetime of Channels 2 and 3

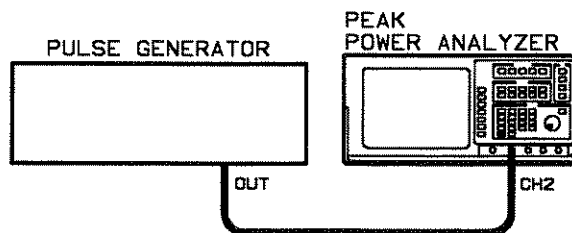

Figure 4-2. Checking Channel 2 and Channel 3 Risetime Equipment Setup

1. Set up the equipment as shown in Figure 4-2.
2. Set the pulse generator as follows:

Period: 20  $\mu$ s

Risetime: < 500 ps

Amplitude: 0.5 volt

3. Press **AUTOSCALE** on the Peak Power Analyzer.
4. Select the **TIMEBASE** menu, and set the following parameter using the displayed menu:

Set the timebase to 5 ns/division using the top function key. Change the timebase with the knob or the keypad. If the keypad is used, terminate the entry with the **ns** key on the right side of the keypad.
5. Make an automatic risetime measurement using the following steps:

Press the **BLUE** key, and then the **RISETIME** (**4**) key.

When **#C** appears at the bottom of the display, press **1**. If **C#** is not displayed, rotate the knob.
6. Read the risetime at the bottom of the Peak Power Analyzer display. The risetime measured by the Peak Power Analyzer should be less than 5 ns.
7. Disconnect the cable from channel 2 and connect it to channel 3.
8. Repeat the procedure for channel 3.

If the Peak Power Analyzer and peak power sensor fail any or all parts of this procedure, refer to the Peak Power Analyzer Service Manual to determine whether the Peak Power Analyzer or the peak power sensor is at fault.

If necessary, results of this procedure can be recorded in the Performance Test Record at the end of this chapter.

## Checking Power Measurement Range

### Specification

Electrical Characteristics	Performance Limits	Conditions
Power Measurement Range	-32 to +20 dBm	

### Description

The power measurement range of the Peak Power Analyzer is measured using a microwave source with wide dynamic range and low harmonics/spurious signals. The source signal is, first, measured with an accurate average power meter system. In this manner, the source output is calibrated to the average power meter system. Then, the calibrated signal is measured with the Peak Power Analyzer and peak power sensor. The tolerance on the Peak Power Analyzer measurement includes the root sum squared, RSS, uncertainty of the average power measurement. The RSS uncertainty is comprised mainly of mismatch errors, sensor calibration factor uncertainty, and power meter measurement errors.

### Equipment

Signal Generator..... HP 83624A  
 (or HP 83620A)  
 Attenuator ..... HP 8493C  
 Attenuator ..... HP 11708A  
 Power Meter ..... HP 437B  
 Power Sensor..... HP 8485A  
 Power Sensor..... HP 8485D  
 Peak Power Sensor..... HP 84813A

**Note**

In order to test the upper limit of the power measurement range (+20 dBm), the HP 83624A (or signal generator with equivalent critical specifications as listed in the Recommended Test Equipment Table) is required. However, you can use the HP 83620A (or equivalent) to test to +10 dBm.

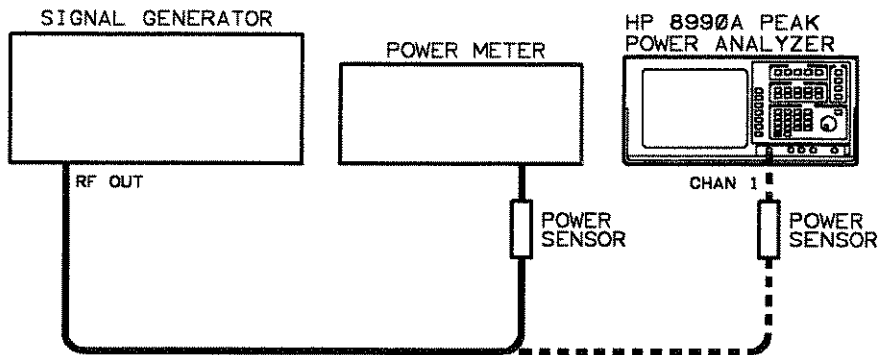

Figure 4-3. Checking Power Measurement Range Equipment Setup

**Procedure****Note**

The measurement limits given in this procedure take into account the system measurement uncertainty. They are included though this is not a measurement accuracy test. If the recommended Hewlett-Packard test equipment is used for this test, the measured value will fall within the range given. If test equipment with different specifications is used for this test, the system measurement uncertainty must be recalculated.

**To set up the test equipment**

1. Set the signal generator output as follows:
  - a. Mode: CW (no modulation)

- b. Frequency: 3 GHz
  - c. Output level: -28 dBm
2. Set the average power meter by zeroing it and entering the (HP 8485D or equivalent) sensor calibration factor for 3 GHz. If necessary, refer to the operating manual of the average power meter for these calibration procedures.

**To set up the Analyzer**

1. Set the Analyzer carrier frequency to 3 GHz.
  - a. Press the **CARRIER FREQ** menu key.
  - b. Press the top function key until **ch1≠ch4** is highlighted.
  - c. Enter 3 GHz with the knob or the keypad.
2. Turn channel 1 **on** and all other channels **off**.
  - a. Press the **CHAN/VERT** menu key.
  - b. Select (highlight) the channel with the top function key.
  - c. Turn the channel **on** or **off** with the second function key.
3. Set the Analyzer display to 1 screen, with **connect dots on** and **grid** selected.
  - a. Press the **DISPLAY** menu key.
  - b. Select 1 with the **# of screens** function key.
  - c. Turn **connect dots on**.
  - d. Highlight (select) **grid**.
4. Select 128 digital averages.
  - a. Press **DISPLAY**.
  - b. Select **avg** with the first function key.

- c. Change the # of avg to 128 using the second function key and the knob.

**Table 4-2.**  
**Average Power Versus Measured Power**

Average Power Level	Recommended Sensor	Number of Averages	Analyzer Measured Power
-32.00 dBm	HP 8485D	128	586 to 674 nW
-20.00 dBm	HP 8485A	64	9.3 to 10.7 $\mu$ W
+0.00 dBm	HP 8485A	16	0.93 to 1.07 mW
+10.00 dBm	HP 8485A	4	9.3 to 10.7 mW
+20.00 dBm	HP 8485A	2	93 to 107 mW

#### To calibrate power

1. Connect the average power sensor (HP 8485D or equivalent) to the average power meter and signal generator RF output as shown in Figure 4-3.
2. Adjust the RF output power level of the signal generator until the power meter reads -32.00 dBm (as listed under **Average Power Level** in Table 4-2).
3. Disconnect the average power sensor from the signal generator and connect the peak power sensor to it. Refer to Figure 4-3.
4. Connect the peak power sensor to **CH 1** of the Analyzer.
5. Set the timebase to 5 ms/div.
  - a. Press the **TIMEBASE** key.
  - b. Press the first function key and enter 5 ms/div using the knob.
6. Set the vertical **scale** to 200 nW/div.
  - a. Press the **CHAN/VERT** key.

- b. Select the **scale** softkey and enter “200 nW/div” using the numeric keyboard and **nW** key.
7. Press the **bandwidth** softkey and choose **low** to select low bandwidth.
8. Set digital averaging to 128 (as listed in Table 4-2) in order to limit noise interference.
  - a. Press **DISPLAY**.
  - b. Select **avg** with the first function key.
  - c. Set **# of avg** to **128** using the second function key and then the knob.

#### To zero the sensor

1. Turn the RF power output of the signal generator off, but, leave the sensor connected to both the RF connector and the Analyzer.
2. Select **sensor zero** under the **CHAN/VERT** menu.

When sensor zeroing is complete, the Analyzer displays: **Sensor zero completed.**
3. Turn the signal generator RF power output on, again.

#### To verify measurement accuracy at -32 dBm

1. Make an automatic average power reading of **CH 1**.
  - a. Press the **BLUE** key, and then the **AVG** (**8**) key.
  - b. Press **1** when **C#** appears at the bottom of the display.

The display will read: **avg(1) XXX** where **XXX** is the current average power in units of mW,  $\mu$ W, or nW.

The Analyzer average power reading should be between 586 and 674 nW as listed under **Analyzer Measured Power** in Table 4-2. (It may be necessary to wait about



two minutes for the display to stabilize because of the digital averaging before reading the average power level.)

**To check power measurement range accuracy**

1. Disconnect the peak power sensor from the signal generator
2. Calibrate the average power meter and sensor (HP 8485A or equivalent). Refer to the power meter manual for this procedure, if necessary.
3. Connect the average power sensor (HP 8485A or equivalent) to the signal generator.
4. Increase the power level of the signal generator until the average power meter reads the next **Average Power Level** (for example, -20 dBm) in Table 4-2.
5. Replace the average power sensor with the peak power sensor.
6. Autoscale the Analyzer by pressing the **AUTOSCALE** key.
7. Decrease digital averaging to the value given under **Number of Averages** in Table 4-2.
8. Make an automatic average power reading.
  - a. Press the **BLUE** key and, then, the **AVG(8)** key.
  - b. Enter **1** when **C#** appears at the bottom of the display.

The display will read: **avg(1) XXX** where XXX is the current average power in units of mW,  $\mu$ W, or nW.

The average power reading should be between the two **Analyzer Measured Power** values listed in Table 4-2.

9. Repeat these steps using all values in Table 4-2 for channel 4 of the Peak Power Analyzer. (Wherever "CH 1" is referred to, substitute "CH 4.")

If the Peak Power Analyzer and peak power sensor fail any or all parts of this procedure, refer to the peak power sensor manual troubleshooting procedure to determine whether the Peak Power Analyzer or the peak power sensor is at fault. If the Peak Power Analyzer is determined to be at fault, refer to the Peak Power Analyzer Service Manual.

If necessary, results of this procedure can be recorded in the Performance Test Record at the end of this chapter.

**Checking  
Instrumentation  
Uncertainty**

**Specification**

Electrical Characteristics	Performance Limits	Conditions
Instrumentation Uncertainty	$\pm 5.5\% + 0.07\mu\text{W}/\text{signal power} \times 100\%$	Includes Noise and Offset

**Description**

Instrumentation Uncertainty is comprised of several errors: vertical calibration uncertainty, quantization error, delta temperature drift, and distortion error.

This performance test is intended to verify that your Peak Power Analyzer meets the specified instrumentation measurement uncertainty. This test verifies only this specification. All other specifications must be verified using the other tests outlined in this chapter.

**Note**

This software package does **NOT** verify that the Peak Power Analyzer is fully calibrated. It only verifies the instrumentation measurement uncertainty of the Peak Power Analyzer. Refer to the "instr cal menu" section of the Utility Menu for complete calibration procedures.

**Controllers**

- Any HP Model 9000 series 200/300 computer.
- At least 4 megabytes of RAM.
- HP-IB interface.
- A 3.5 inch dual sided floppy drive unit.

**Operating System** HP BASIC 5.1 with the following language extensions loaded:

Name	Description
GRAPH	Graphics
GRAPHX	Graphics Extensions
IO	I/O
TRANS	Transfer
MAT	Matrix Statements
PDEV	Program Development
XREF	Cross Reference
KBD	Keyboard Extensions
CLOCK	Clock
MS	Mass Storage
SRM	Shared Resource Management
ERR	Error Messages
DISC	Small Disc Driver
CS80	CS80 Disc Driver
HPIB	HPIB Interface Driver
CRTB	Bit-mapped CRT Driver
CRTA	Alpha CRT Driver
COMPLEX	Complex Arithmetic
CRTX	CRT Extensions
EDIT	List and Edit
HFS	Hierarchical File System

Equipment		
Multimeter.....	HP 3458A	
Universal Source.....	HP 3245A	
Switch Driver .....	HP 11713A	
Attenuator (0-70 dB) .....	HP 8495G	
Attenuator (20 dB) .....	HP 8491A (Option 020)	
50 Ohm Termination.....	HP 1250-0207	
Adapter (SMC to BNC) ....	HP 1250-0331	
Peak Power Sensor Cable ...	HP 84812-60008	
Controller.....	HP 9000 Series 200\300	
Thinkjet Printer.....	HP 2225A	

**Installing the Software**

The software needed to perform this test is located in the calibration guide kit.

**Using a Floppy Disc Drive**

Make a backup copy of the supplied disks.

Make sure that your working disk is write-enabled.

**Using a Shared Resource Management (SRM) or Hierarchical File System (HFS) Hard Disc**

Create a directory that will contain the program and its associated files. Copy all of the files on the 3.5 inch disk to this directory.

**Running the Software****Caution**

---

This software used RAM memory volumes for fast access of data files. These volumes may also be used by other programs and could contain data that will be erased by the program. Make sure that the computer you are using does not have important data in any memory volumes before running this software.

---

1. Make sure that the software has been copied into a directory (if HFS or SRM) or copied to a work disk (if running from a floppy).
2. Set the default mass storage to the directory or floppy disk that contains the test software. This is done using the BASIC MSI command. See the BASIC Language Reference for more information on setting the default mass storage.
3. Load the program by typing LOAD "IUM\_8990" and pressing ENTER or RETURN.
4. Start the test program by typing RUN and pressing ENTER or RETURN.

5. The program will ask you for the unit under test's serial number and installed options. Enter the appropriate information.
6. A menu containing the available tests will be displayed. Simply select the test you wish to run, using the arrow keys, and hit RETURN. Individual tests will prompt you with connection instructions or other relevant test information. Respond in an appropriate manner. When the test has completed, a test report will be output and then you will return to the test menu. (This test will require 20 minutes per channel).
7. Either select another test to run or press the QUIT softkey to exit the program.

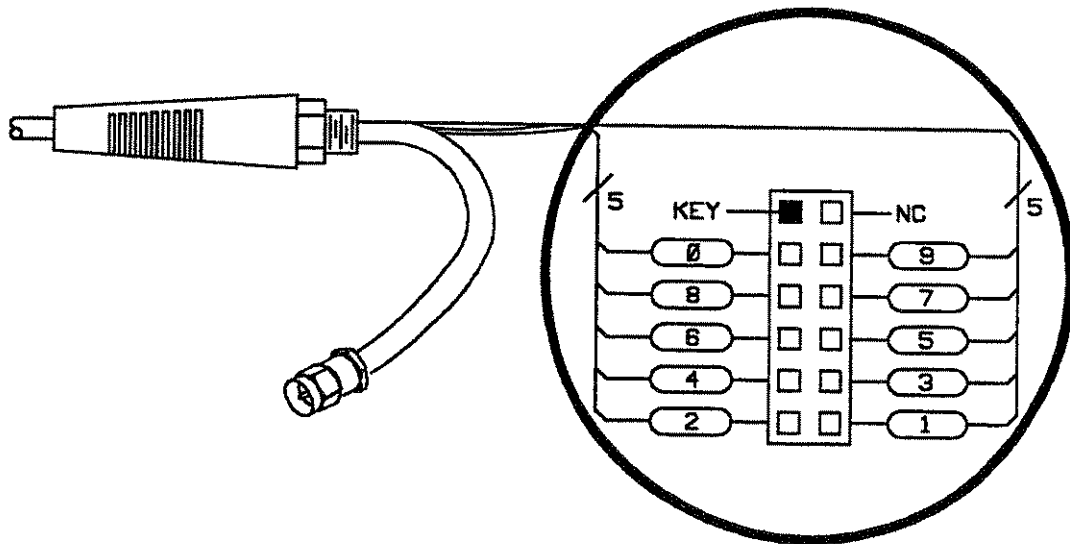

Figure 4-4. Peak Power Sensor Cable Electrical Connector

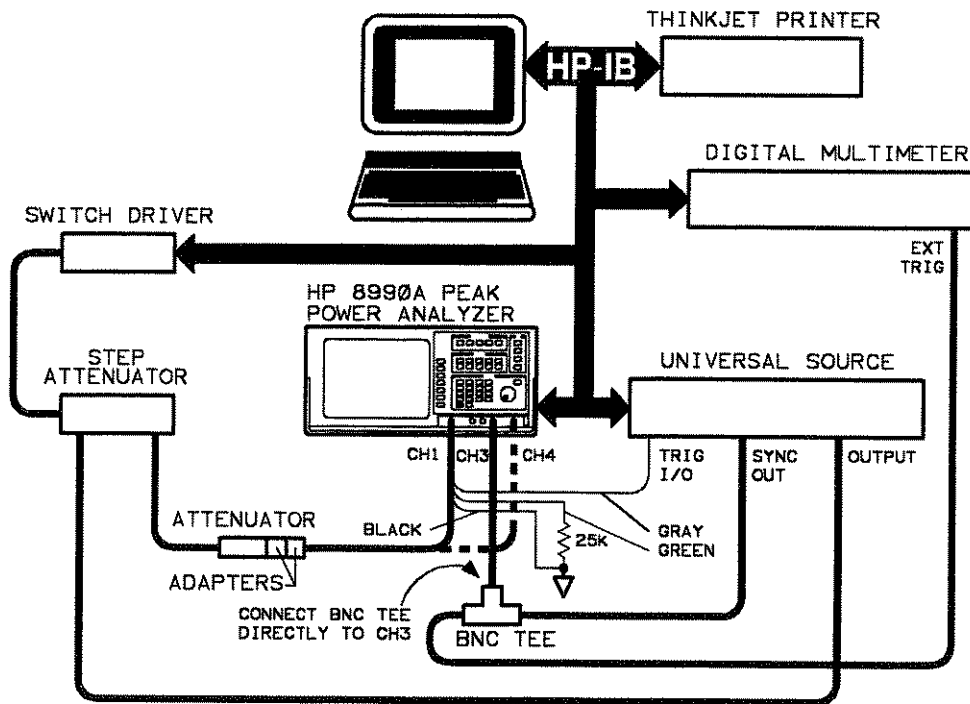

Figure 4-5a. Signal Level Measurement

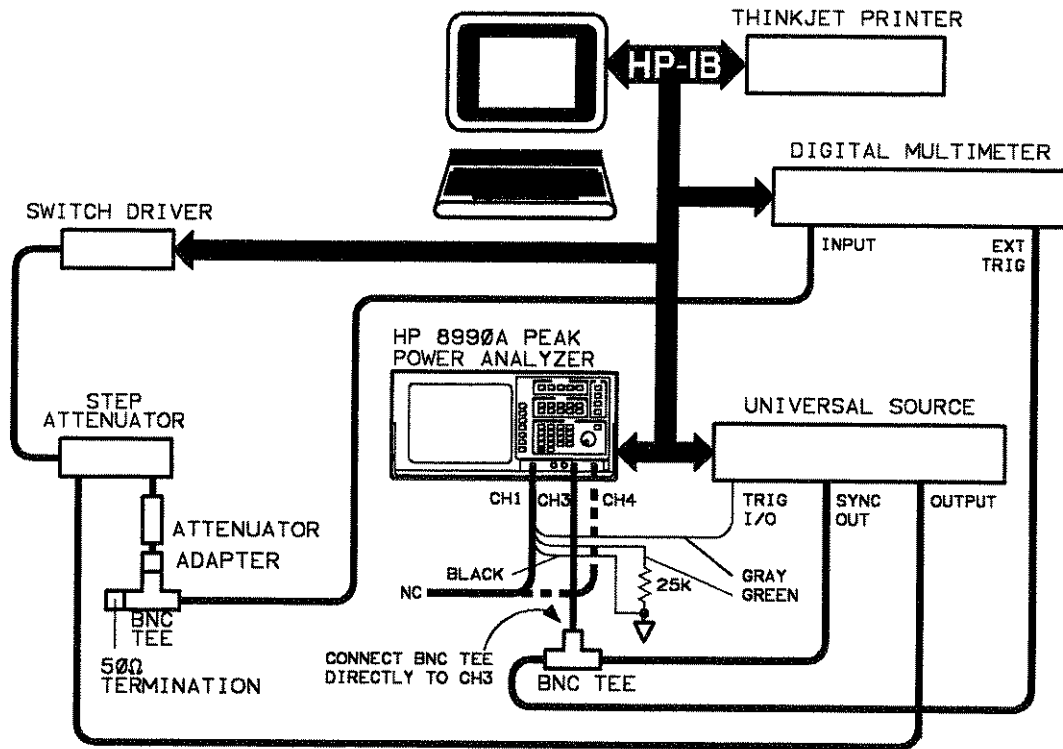

Figure 4-5b. Signal Level Verification



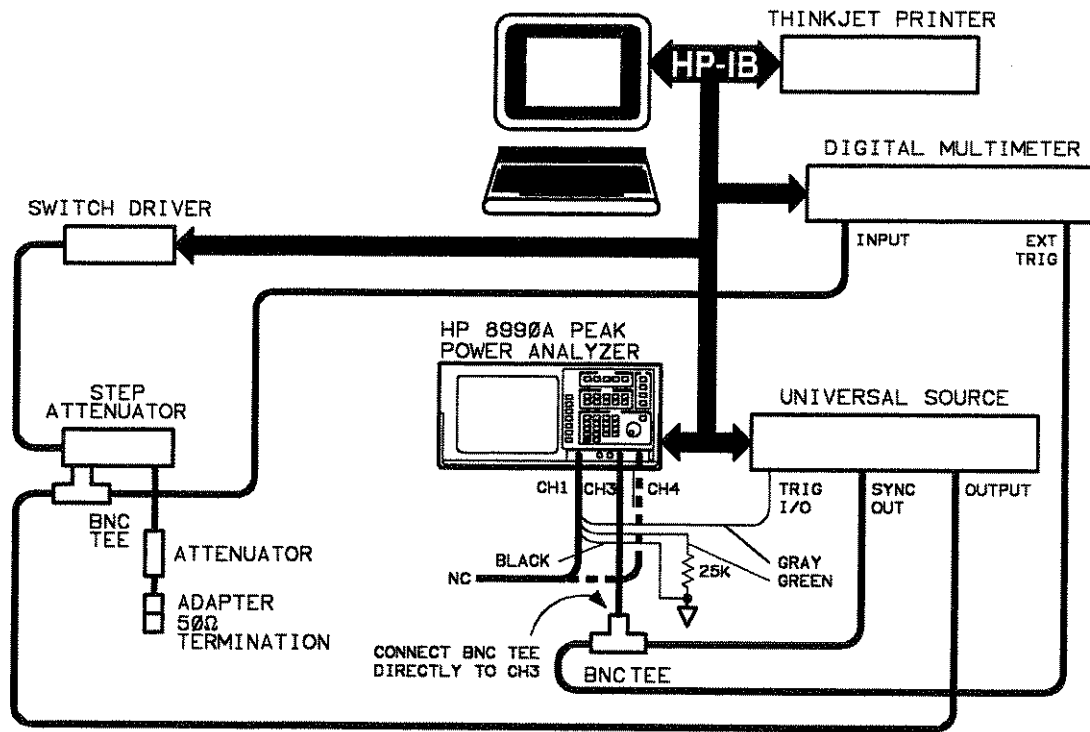

Figure 4-5c. Measurement System Error Correction

**Checking Sensor  
Check Source  
Power Level**

**Specification**

Electrical Characteristics	Performance Limits	Conditions
Power Level	+10 dBm ±0.5 dB	

**Description**

Since it is basically independent of other instrument circuits, the output level of the Sensor Check Source is checked with the Peak Power Analyzer and peak power sensor. Both the CW and pulse power levels are checked.

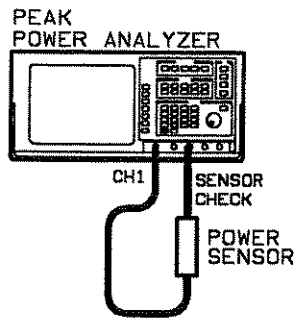

**Figure 4-6. Checking Sensor Check Source Equipment Setup**

**Equipment** Peak Power Sensor . . . . . HP 84812A, 84813A, 84814A, or 84815A

**Note**

Prior to performing this test, the performance tests which verify proper operation of channel 1 on the Peak Power Analyzer and operation of the peak power sensor should be complete. These tests include Checking Power Measurement Range, Checking Instrumentation Uncertainty, and Checking Sensor SWR.

**Procedure****To set up the equipment**

1. Connect the equipment as shown in Figure 4-6.
2. Turn on the sensor check source and set it to cw mode.
  - a. Press the **UTIL** key.
  - b. Press the **check: source** function key until **CW** is highlighted.
3. Set the carrier frequency to 1 GHz.
  - a. Press the **CARRIER FREQ** menu key.
  - b. Enter 1 GHz using the keypad or the knob. If the keypad is used, the entry must be terminated with the **GHz** key.
4. Press **AUTOSCALE** to automatically scale the signal to the Peak Power Analyzer display.

Wait until the message **running** appears at the top of the display before proceeding.

**To measure sensor check source power**

1. Make an automatic average power measurement.
  - a. Press the **BLUE** key and then the **AVG (8)** key.
  - b. Press **1** when **C#** appears at the bottom of the display.

The display will read: `avg<1> XXX` where XXX is the current average power measured.

The average power displayed should be between 8.9 mW and 11.2 mW (10 dBm  $\pm$ 0.5 dB).

2. Change the sensor check source power to pulse.
  - a. Select the **UTIL** menu.
  - b. Set the **check source** to pulse mode (highlight **pulse**).
3. Autoscale the Peak Power Analyzer by pressing **AUTOSCALE**.
4. Make a pulse "top" measurement.
  - a. Press the **BLUE** key and then the **TOP** (**9**) key.
  - b. Press **1** when **C#** appears at the bottom of the display.

The average power displayed should be between 8.9 mW and 11.2 mW (10 dBm  $\pm$ 0.5 dB).

If either part of the test fails and all RF channel and sensor performance tests have passed, refer to the Peak Power Analyzer Service Manual.

If necessary, results of this procedure may be recorded in the Performance Test Record at the end of this chapter.

## Checking Bandwidth

### Specification

Electrical Characteristics	Performance Limits	Conditions
Bandwidth	dc to 100 MHz	Repetitive
	dc to 1 MHz	Single-shot

**Description** This test measures the bandwidth of channels 2 and 3 at the  $-3$  dB point. The bandwidth limits are verified by inputting a signal of known frequency and power to the Peak Power Analyzer and to an average power meter system.

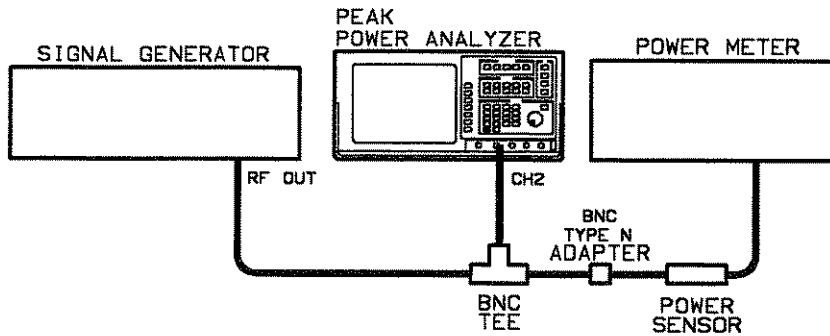

Figure 4-7. Checking Bandwidth Equipment Setup

<b>Equipment</b>	Signal Generator.....	HP 8657B
	Power Meter .....	HP 437B
	Power Sensor.....	HP 8482A

**Procedure****To set up the test equipment and Peak Power Analyzer**

1. Connect the equipment as shown in Figure 4-7.
2. Set the signal generator to 100 kHz and 0 dBm.
3. Press **RECALL** and then **CLEAR** on the Peak Power Analyzer.
4. Press **AUTOSCALE** on the Peak Power Analyzer.
5. Press the **DISPLAY** menu key, and select (highlight) **grid** from the displayed menu.
6. Set the Peak Power Analyzer scale to 100 mV/div using the following steps:
  - a. Press the **CHAN/VERT** menu key.
  - b. Select the third function key.
  - c. Set the scale to 100 mV/div using the keypad or the knob. If the keypad is used, terminate the entry with the **mV** key.
7. Adjust the signal generator output power so the waveform is exactly eight divisions peak-to-peak.
8. Adjust the **offset** as needed to center the waveform on the Peak Power Analyzer display using the following steps:
  - a. Select the fourth function key.
  - b. Set the offset with the keypad or the knob. If the knob is used, more resolution may be selected by pressing the **FINE** key.
9. On the average power meter, enter the calibration factor for 100 kHz.

**To verify the bandwidth limits of Channels 2 and 3**

1. Set the power meter to make a relative measurement. Make the reference 0 dB.

2. Change the signal generator to 100 MHz.
3. Set the Peak Power Analyzer timebase to 10 ns/division using the following steps:
  - a. Press the **TIMEBASE** menu key.
  - b. The timebase is enabled (highlighted) when the menu is selected. Adjust the timebase using the keypad or the knob.
4. Adjust the Peak Power Analyzer trigger level, if necessary, for a stable display.
  - a. Select the **TRIG** menu key.
  - b. Verify that the **source** is set (highlighted) to **2**.
  - c. Adjust the **level** with the keypad or knob until the waveform is stable.
5. On the average power meter, enter the calibration factor for 100 MHz.
6. Adjust the signal generator output power for 0 dBm as read on the power meter.
7. Observe the waveform on the Peak Power Analyzer display. The waveform should be greater than or equal to 5.6 divisions peak-to-peak.
8. Disconnect the signal generator from channel 2 and connect it to channel 3.
9. Repeat this full procedure for channel 3.

If either of the measurements failed, refer to the Peak Power Analyzer Service Manual.

If necessary, test results may be recorded in the performance test record at the end of this chapter.

## Checking Offset Accuracy

### Specification

Electrical Characteristics	Performance Limits	Conditions
Offset Accuracy	$\pm 2\%$ of offset + $0.2 \times (\text{V/div})$	

### Description

This test measures an average dc voltage at maximum vertical offset on channels 2 and 3. The offset accuracy is checked by supplying an accurate voltage and displaying it at a known offset and vertical sensitivity. The offset and scale are chosen such that the calculated maximum permissible offset from the center of the display is easily read using the division markings on the screen.

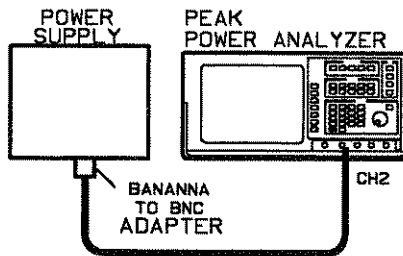

**Figure 4-8. Checking Offset Accuracy Equipment Setup**

### Equipment Required

Power Supply ..... HP 6114A  
 BNC to Banana Plug Adapter..... HP 1251-2277



**Procedure****To set up the test equipment and the Peak Power Analyzer**

1. Connect the equipment as shown in Figure 4-8.
2. Press **RECALL** and then **CLEAR** on the Peak Power Analyzer.
3. Adjust the power supply to read +1.00 volt.
4. On the Peak Power Analyzer, press the **DISPLAY** menu key, and select (highlight) **grid** with the fifth function key.
5. Set the timebase to 1  $\mu$ s/division using the following steps:
  - a. Select the **TIMEBASE** menu key.
  - b. Set the timebase using the keypad or the knob. If the keypad is used, terminate the entry with the  $\mu$ s key.
6. On the Peak Power Analyzer, turn channel 2 on and the other channels off using the following steps:
  - a. Press the **CHAN/VERT** menu key.
  - b. Press the top function key, and select (highlight) the desired channel.
  - c. Press the second function key until **on** or **off** is highlighted.

**To verify offset accuracy for Channel 2**

1. Set the Peak Power Analyzer scale to 100 mV/division with the following steps:
  - a. Press the third function key.
  - b. Set the scale using the keypad or the knob.
2. Set the Peak Power Analyzer coupling to **dc**.

- a. Press the fifth function key until **dc** is highlighted.
3. Set the **offset** on the Peak Power Analyzer to 1 volt.
  - a. Press the fourth function key.
  - b. Set the offset using the keypad or the knob.
4. Verify that the level displayed on the Peak Power Analyzer is within 0.4 divisions of the center horizontal line (as calculated from the vertical sensitivity and offset).
5. Select a scale of 200 mV/division on the Peak Power Analyzer.
6. Set the Peak Power Analyzer offset to +2 volts.
7. Adjust the power supply to +2.00 volts.
8. Verify that the level displayed on the Analyzer is within 0.4 divisions of the center horizontal line.

**Note**

---

The performance test is temperature sensitive. Test limits given in this procedure assume that the instrument is operating at the temperature at which it was calibrated. If the operating temperature is not the same as the calibration temperature, the error is increased by 0.075 divisions/degree C change (0.15 divisions/degree C change, on 5 mV/division range).

---

**To verify offset accuracy for Channel 3**

1. Disconnect the input to **CH 2** and connect it to **CH 3**.
2. Turn channel 3 on and channel 2 off.
3. Set the scale for channel 3 to 200 mV/division.
4. Set the offset for channel 3 to + 2 volts.
5. Verify that the Peak Power Analyzer signal level displayed is within 0.4 divisions of the center horizontal line.

6. Change the power supply to +1.00 volt.
7. Set the Peak Power Analyzer scale to 100 mV/div.
8. Set the offset to 1 volt.
9. Verify that the level displayed is within 0.4 divisions of the center horizontal line.

If any portion of this test fails, refer to the Peak Power Analyzer Service Manual.

If necessary, you may record the measurement results of this test in the Performance Test Record at the end of this chapter.

## Checking Channel 1 and Channel 4 Trigger Sensitivity

### Specification

Electrical Characteristics	Performance Limits	Conditions
Trigger Sensitivity	0.25 x full scale	Internal Trigger > -30 dBm
Bandwidth	Equal to video bandwidth when < 1 MHz	Internal Trigger

### Description

The channel 1 and channel 4 trigger sensitivity performance test verifies that the Peak Power Analyzer can trigger on a signal equal to the specified sensitivity. A signal generator is connected to the Peak Power Analyzer. The signal generator output is slowly decreased and a stable trigger level is found for various signal levels. The minimum triggerable signal level is then measured.

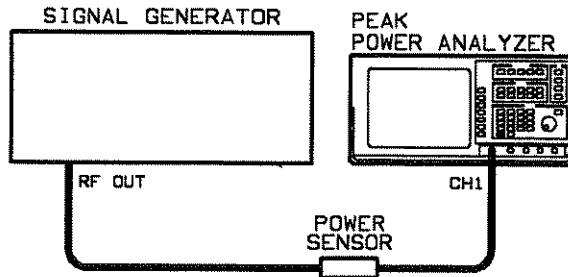

**Figure 4-9.**  
**Checking Channel 1 and Channel 4 Trigger Sensitivity Equipment Setup**

<b>Equipment</b>	Signal Generator.....	HP 83620A (or HP 83624A)
	Peak Power Sensor.....	HP 84812A/84813A/ 84814A/84815A

**Procedure****To set up the test equipment and the Peak Power Analyzer**

1. Set the signal generator as follows:
  - Frequency: 3 GHz
  - Output Level: -17 dBm
  - Pulse width: 1 ms
  - Repetition rate: 600 Hz
2. Set up the display with a grid and 128 digital averages.
  - Press the **DISPLAY** key.
  - Select (highlight) **grid** with the 5th function key from the top.
  - Select **avg** with the top function key.
  - Change # of **avg** to **128** using the knob.
3. Connect the peak power sensor to **CH 1** as in Figure 4-9.
4. Turn channel 1 **on** and all other channels **off**.
  - Press the **CHAN/VERT** menu key.
  - Highlight the desired channel. Turn the channel **on** or **off** using the second function key.
5. Set the carrier frequency of the Peak Power Analyzer to 3 GHz.
  - Press the **CARRIER FREQ** menu key.

Press the top function key until **ch1≠ch4** is highlighted.

Enter 3 GHz with the knob or the keypad.

6. Select low bandwidth.

Press the **CHAN/VERT** key.

Select the **bandwidth** softkey and highlight **low**.

#### To measure power with the Peak Power Analyzer

1. Connect the peak power sensor to the signal generator as in Figure 4-9.
2. Press **AUTOSCALE** to scale the signal on the Peak Power Analyzer display.

The Analyzer has finished autoscaling the signal when it displays the message: "running" or "autotriggering".

3. Make an automatic average power measurement with the Analyzer.
  - a. Press the **BLUE** Shift key.
  - b. Press the Avg (**8**) key.
  - c. When Ch# appears on the bottom of the display, press **1**.
4. Turn on the continuous measurement feature of the Analyzer so that average power is continuously measured.
  - a. Press **DEFINE MEAS**.
  - b. Turn **continuous on** using the second function key.

The Analyzer display will read: **avg (1) XXX** where XXX is the current average power measured. (The value of average power is not relevant at this point.)

**To verify internal triggering down to 0.25 of full scale**

1. Slowly decrease the power level of the signal generator to approximately  $-19$  dBm (or about  $12 \mu\text{W}$  as measured by the Analyzer).

**Note**

---

Before continuing with this procedure, wait about one minute for the display to respond to the change in power level since digital averaging is being used.

---

2. Adjust the Analyzer **scale** so that the signal displays full scale (over 8 divisions vertically).
  - a. Press **CHAN/VERT**.
  - b. Change the **scale** with the third function key and the numeric keyboard.
3. Press the **TRIG** key and lower the trigger **level** so that a stable signal is displayed. (The trigger level is represented by the horizontal broken line.)
4. Continue to lower the trigger **level** (horizontal broken line) down to two divisions above the baseline. The display should be stable at this trigger level.

**To verify triggering for a  $-30$  dBm signal**

1. Slowly decrease the power level by several dB.
2. Adjust the **scale** so that the signal displays full scale.
3. Adjust the trigger **level** to achieve a stable display.
4. Continue to decrease the power and adjust the **scale** and trigger **level** until the Analyzer displays a stable  $1 \mu\text{W}$  signal full scale. (The **scale** should be in the vicinity of  $200 \text{ nW}$ .)

5. Lower the trigger level down to two divisions above the baseline.

With a  $-30$  dBm ( $1 \mu\text{W}$ ) (or greater) signal, the Analyzer should be able to trigger down to 2 divisions and achieve a stable display.

6. Repeat the verification procedure for channel 4.

If any of the measurements fail, refer to the troubleshooting section in the Peak Power Analyzer Service Manual.

If necessary, you may record measurement results in the Performance Test Record at the end of this chapter.



## Checking Channel 2 and 3 Trigger Sensitivity

### Specification

Electrical Characteristics	Performance Limits	Conditions
Trigger Sensitivity	0.2 V pp	dc-1 MHz
	0.5 V pp	1 MHz-100 MHz

### Description

The channel 2 and 3 trigger sensitivity test verifies that the Peak Power Analyzer can trigger on a signal equal to the specified sensitivity. To verify external trigger sensitivity, the minimum triggerable signal, as displayed on the Peak Power Analyzer, is input to channel 2 or 3. The trigger level is then adjusted until a stable display is achieved.

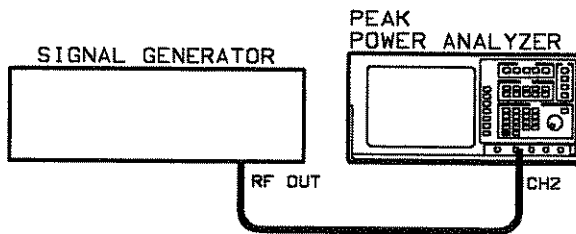

Figure 4-10.  
Checking Channel 2 and Channel 3 Trigger Sensitivity  
Equipment Setup

**Equipment** Signal Generator..... HP 8657B

**Procedure**

**To set up the test equipment and the Peak Power Analyzer**

1. Connect the equipment as shown in Figure 4-10.
2. Press the **DISPLAY** menu key, and select (highlight) **grid** with the fifth function key.

**To check Channel 2 and 3 trigger sensitivity from dc to 1 MHz**

1. Set the signal generator to 1 MHz and approximately 0 dBm.
2. Press **AUTOSCALE** on the Peak Power Analyzer.
3. Adjust the trigger level for a stable display, if necessary with the following steps:
  - a. Press the **TRIG** menu key.
  - b. Adjust the **level** with the knob or the keypad. If the knob is used, press the **FINE** key for more resolution.
4. Adjust the signal generator amplitude for a 200 mV peak-to-peak signal as displayed on the Peak Power Analyzer. If desired, use the following steps to adjust the vertical sensitivity of the channel:
  - a. Select the **CHAN/VERT** menu.
  - b. Press the third function key.
  - c. Change the vertical scale with the knob or the keypad. If the keypad is used, terminate the entry with one of the suffix keys on the right side of the keypad.

5. Adjust the Peak Power Analyzer trigger level for a stable display. If the display can be stabilized, the trigger sensitivity from dc to 1 MHz test passes.

If a stable trigger level is not found, the test fails.

6. Repeat the channel 2 and 3 trigger sensitivity procedure from dc to 1 MHz for channel 3.

If necessary, you may record the measurement results of this test in the Performance Test Record at the end of this chapter.

#### **To check Channel 2 and 3 trigger sensitivity from 1 MHz to 100 MHz**

1. Disconnect the signal generator output from channel 3 and connect it to channel 2.
2. Change the signal generator output to 100 MHz and 0 dBm.
3. Press **AUTOSCALE**.
4. Adjust the signal generator amplitude for a 500 mV peak-to-peak signal as displayed on the Peak Power Analyzer.
5. Adjust the Peak Power Analyzer trigger level for a stable display.

If the display can be stabilized, the trigger sensitivity from 1 MHz to 100 MHz test passes.

If a stable trigger level is not found, the test fails.

6. Repeat this procedure for channel 3.
7. If any of the measurements fail, refer to the troubleshooting section in the Peak Power Analyzer Service Manual.

If necessary you may record measurement results in the Performance Test Record at the end of this chapter.

## Checking Delta-t Accuracy

### Specification

Electrical Characteristics	Performance Limits	Conditions
Delta-t Accuracy	$1 \text{ ns} \pm (5E-5) \times \text{Delta } t \pm 0.02 \times (t/\text{division})^1$	

<sup>1</sup> Delta t accuracy for dual-cursor, single-channel measurement, or for channel-to-channel measurement after visual time null calibration has been done.

### Description

Timebase linearity and the 100 MHz startable oscillator accuracy are the variables that determine delta-t accuracy. Delta-t accuracy is checked by supplying a very stable signal to channels 2 and 3. Then, the timebase and the measured delta-t are used to calculate delta-t accuracy according to the following equation:  $1 \text{ ns} \pm (5E-5) \times \text{Delta-t} \pm 0.02 \times (t/\text{division})$ . Digital averaging is used to minimize the influence of noise.

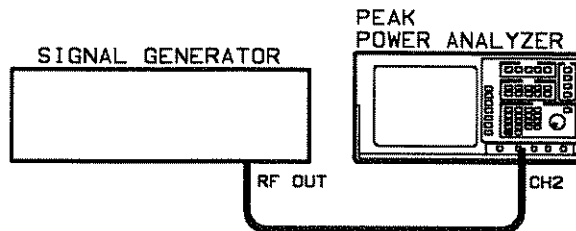

Figure 4-11. Checking Delta-t Accuracy Equipment Setup

<b>Equipment</b>	Signal Generator.....	HP 8657B
	BNC Cable .....	HP 10503A

**Procedure****To set up the test equipment and the Peak Power Analyzer**

1. Connect the equipment as shown in Figure 4-11.
2. Set the signal generator to 100 MHz and 0 dBm.
3. Press **AUTOSCALE** on the Peak Power Analyzer.
4. Adjust the signal generator's output power until the waveform displayed on the Analyzer is between 6 and 8 divisions peak-to-peak.
5. Change the timebase to 5 ns/division, and set the delay to 0.00000 seconds using the following steps:
  - a. Select the **TIMEBASE** menu key.
  - b. Change the timebase (top function key) and the delay (second function key) by pressing the desired function key and entering the time using the keypad or the knob. If the keypad is used, terminate the entry with one of the time suffix keys.
6. Press the **DISPLAY** menu key. Set the following parameters using the displayed menu:
  - a. Push the top function key until **avg** is highlighted.
  - b. Set the **# of avg** to **2048** with the keypad or the knob. If the keypad is used, terminate the entry with any of the suffix keys.
  - c. Press the fifth function key until **grid** is highlighted.
  - d. Press **connect dots** until **on** is highlighted.

## Using the markers to measure delta t

1. Select the **MKRS** menu.
2. Press the **time markers** key until **on** is highlighted.
3. Select the **start marker** function key.
4. Set the start marker (large dashed vertical line) to the mid-screen crossover point on the left side of the displayed signal as shown in Figure 4-12. The knob changes the position of the marker.
5. Select the **stop marker** function key.
6. Set the stop marker (small dashed vertical line) to the mid-screen crossover point on the right side of the displayed signal as shown in Figure 4-12.
7. Read the delta-t from the bottom of the display. It should be between 38.7 and 41.3 ns.

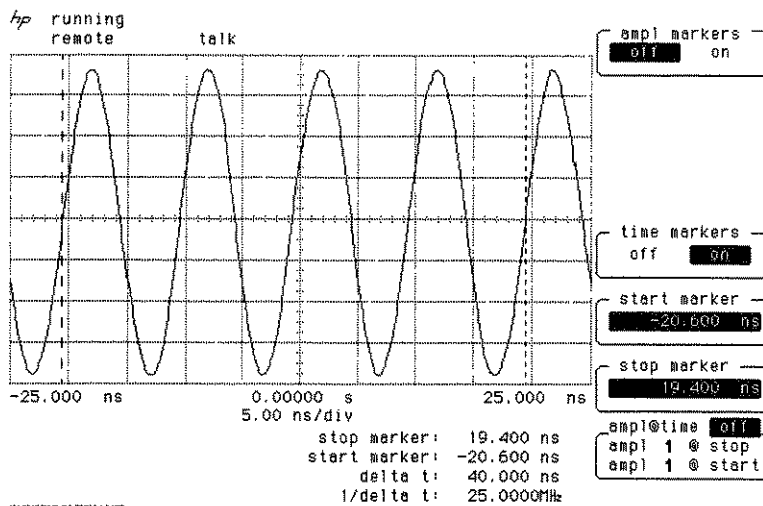

Figure 4-12. Mid-Screen Crossover

8. Disconnect the signal generator from channel 2 and connect it to channel 3.
9. Repeat the procedure for channel 3.

If delta-t accuracy fails on either channel, refer to the Peak Power Analyzer Service Manual.

If necessary, you may record measurement results in the Performance Test Record at the end of this chapter.

**Performance Tests**

**HP 8990A**

**Table 4-3. Performance Test Record**

Hewlett-Packard Company  
HP 8990A Peak Power Analyzer

Tested By \_\_\_\_\_

Serial Number \_\_\_\_\_

Date \_\_\_\_\_

Test	Minimum	Actual	Maximum
<b>RISETIME AND FALLTIME</b>			
Channels 1 and 4			
2 mW (+3 dBm)		_____	5 ns <sup>1</sup>
25 μW (-16 dBm)		_____	6 ns <sup>1</sup>
2.5 μW (-26 dBm)		_____	1 μs
0.63 μW (-32 dBm)		_____	80 μs
<b>RISETIME AND FALLTIME</b>			
Channels 2 and 3		_____	5 ns
<b>POWER MEASUREMENT RANGE</b>			
-32 dBm	586 nW	_____	674 nW
-20 dBm	9.3 μW	_____	10.7 μW
+0 dBm	0.93 mW	_____	1.07 mW
+10 dBm	9.3 mW	_____	10.7 mW
+20 dBm	93 mW	_____	107 mW
<b>INSTRUMENTATION UNCERTAINTY</b>			
	Fail	_____	Pass
<b>SENSOR CHECK SOURCE POWER LEVEL</b>			
CW	8.9 mW	_____	11.2 mW
Pulse	8.9 mW	_____	11.2 mW
<b>BANDWIDTH</b>			
Channel 2	5.6 Divisions	_____	
Channel 3	5.6 Divisions	_____	

<sup>1</sup> Specification for the HP 84815A is <45 ns.



Performance Test Record (continued)

Test	Minimum	Actual	Maximum
<b>OFFSET ACCURACY</b>			
1 Volt (Channel 2)		_____	0.4 Divisions
1 Volt (Channel 3)		_____	0.4 Divisions
2 Volts (Channel 2)		_____	0.4 Divisions
2 Volts (Channel 3)		_____	0.4 Divisions
<b>TRIGGER SENSITIVITY</b>			
<b>Stable Display at 500 <math>\mu</math>W</b>			
Channel 1		_____	2 Division
Channel 4		_____	2 Division
<b>Stable Display at 5 <math>\mu</math>W</b>			
Channel 1		_____	2 Division
Channel 4		_____	2 Division
<b>Stable Display at 500 nW</b>			
Channel 1		yes/no	
Channel 4		yes/no	
<b>Stable Display at 1 MHz</b>			
Channel 2		yes/no	
Channel 3		yes/no	
<b>Stable Display at 100 MHz</b>			
Channel 2		yes/no	
Channel 3		yes/no	
<b>DELTA-T ACCURACY</b>			
Channel 2	38.7 ns	_____	41.3 ns
Channel 3	38.7 ns	_____	41.3 ns

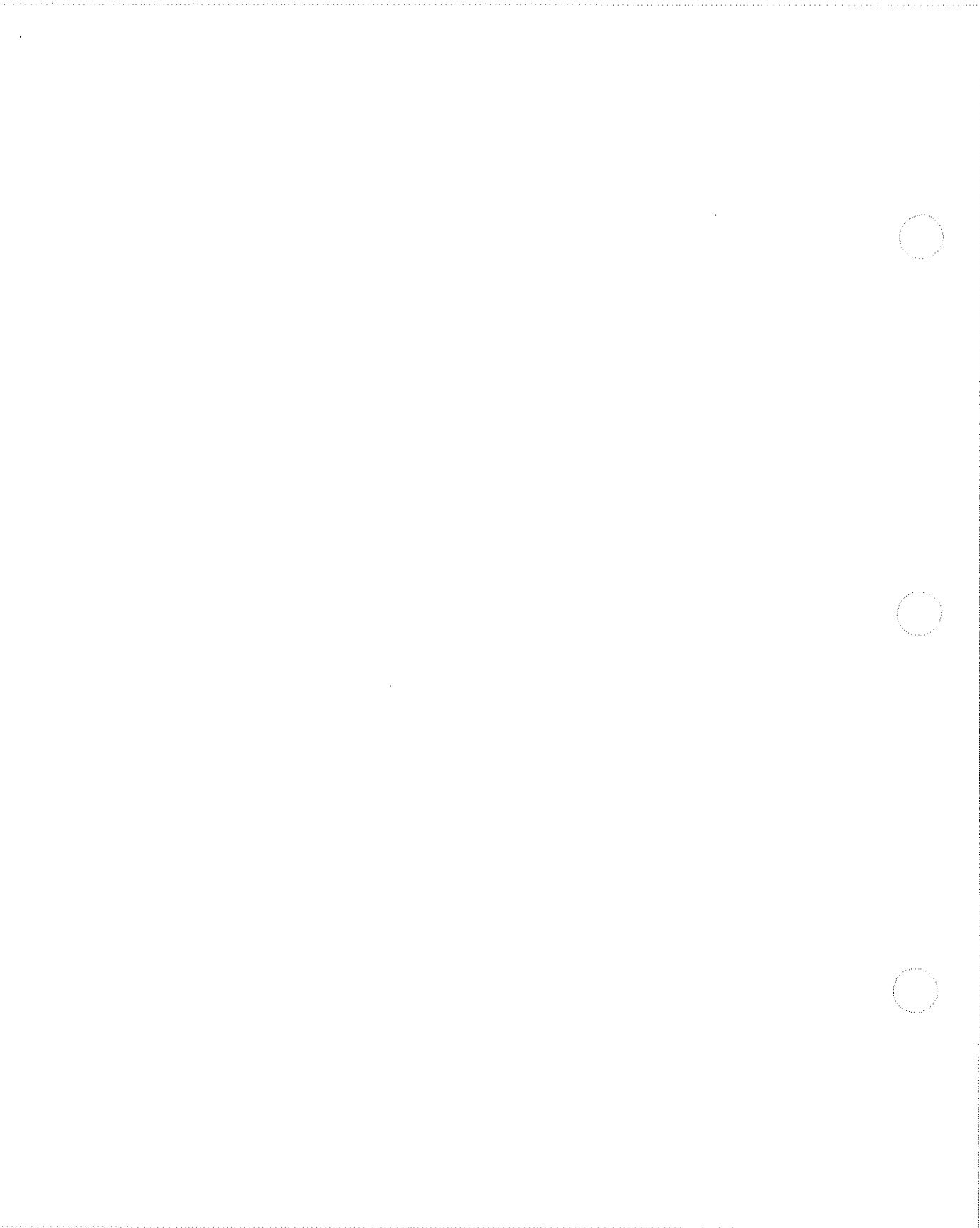

## Algorithms

---

### Introduction

One of the Peak Power Analyzer's primary features is its ability to make automatic measurements on displayed waveforms. This appendix provides details on how automatic measurements are calculated and offers some tips on how to improve results.

---

### Measurement Setup

Measurements typically should be made at the fastest possible sweep speed for the most accurate measurement results. The entire portion of the waveform that is to be measured must be displayed on the Analyzer. That is:

- at least one complete cycle must be displayed for PRI (Pulse Repetition Interval) or PRF (Pulse Repetition Frequency) measurements
- the rising edge followed by the negative edge must be displayed for pulse width measurements
- the falling edge followed by the rising edge must be displayed for offtime measurements
- the leading edge of the waveform and enough of the pulse to define the top and base must be displayed for risetime measurements and all other edge measurements
- the trailing edge of the waveform must be displayed for falltime measurements and all other edge measurements

- the top, base, and peak of the waveform must be displayed for overshoot measurements.

---

## Making Measurements

If more than one waveform, edge, or pulse is displayed, the measurements are made on the first (leftmost) portion of the displayed waveform that can be used. If there are not enough data points, the Analyzer will display  $\leq$  with the measurement results. This is to remind you that the results may not be as accurate as possible. It is recommended that you re-scale the displayed waveform and make your measurement again.

When any of the standard measurements are requested, the Peak Power Analyzer first determines the top-base linear amplitude levels at 100%-0%. From this information, it can determine the other important linear amplitude values (10%, 90%, and 50%) needed to make the measurements. The 10% and 90% linear amplitude values are used in the risetime and falltime measurements as well as in all other edge measurements. The 10% and 90% values are also used to determine the 50% value. The 50% linear amplitude value is used for measuring PRF, PRI, pulse width, and duty cycle.

---

## Automatic Top-Base

Top-Base is the heart of most automatic measurements. It is used to determine  $V_{top}$  and  $V_{base}$ , the 0% and 100% linear amplitude levels at the top and the bottom of the waveform. From this information the Analyzer can determine the 10%, 50%, and 90% points, which are also used in most measurements. The top or base of the waveform is not necessarily the maximum or minimum linear amplitude present on the waveform. Consider a

pulse that has slight overshoot. It would be wrong to select the highest point of the waveform as the top since the waveform normally rests below the perturbation.

Top-Base performs a histogram on the waveform and finds the most prevalent point above and below the waveform midpoint. The most prevalent point is one that represents greater than approximately 5% of the total display points (501) and is considered to be either the top or base. If no point accounts for more than 5% of the total, then the top is chosen as the absolute maximum and the base is chosen as the absolute minimum.

If the top or base arrived at in the measurement is different from what is expected, the measurement results may also be different than expected. If there is doubt, turn continuous measurements off in the Define Measure Menu and repeat the measurement to observe where the markers are placed on the waveform.

---

## Edge Definition

Both rising and falling edges are defined as transitional edges that must cross three thresholds.

A rising edge must cross the lower threshold in a positive direction (defining it as a rising edge), cross the mid threshold (any number of crossings, both positive and negative are permissible) and then cross the upper threshold without any crossing of the lower threshold.

A falling edge must cross the upper threshold in a negative direction, cross the mid threshold (any number of times), and then cross the lower threshold without crossing the upper threshold.

**Note**

Most time measurements are made based on the position of the first crossing of the middle threshold.

---

**Algorithm  
Definitions**

Following are the definitions that all measurements are based on:

**delay**

There are three types of delay measurement:

- jitter
- standard
- user-defined

Jitter occurs only under the following circumstances:

- standard/user-defined key is set to standard
- two delay parameters are the same
- display mode is envelope

if

    first edge on minimum waveform is rising

then

    delay = mid-threshold of first rising edge of max  
    waveform minus mid-threshold of first rising edge on  
    min waveform

else

    delay = mid-threshold of first falling edge on min  
    waveform minus mid-threshold of first falling edge  
    on max waveform

The standard delay measurement occurs when in the standard mode (not user-defined) and is not a jitter measurement.

standard delay = mid-threshold of the first edge of  
second parameter minus mid-threshold of the first  
edge of the first parameter

**Note**

---

Negative delay is possible

---

User defined delay = second channel edge minus first  
channel edge

**Pulse Width**

The pulse width algorithm has standard and user-defined  
considerations.

if

    first edge is rising

then

    Pulse width= mid-threshold crossing of first falling  
    edge minus mid-threshold crossing of first rising  
    edge

else

    Pulse width= mid-threshold crossing of second  
    falling edge minus mid-threshold crossing of first  
    rising edge

User-defined is the same as Standard definition except  
user-defined threshold.

**Offtime**

The offtime algorithm has standard and user-defined  
considerations:

if

    first edge is rising

then

    offtime= second rising edge—first falling edge

else

offtime= first rising edge–first falling edge

**PRI** if  
 first edge is rising  
 then  
 PRI = second rising edge–first rising edge  
 else  
 PRI = second falling edge–first falling edge

**PRF** PRF= 1/PRI

**Duty Cycle** duty cycle = (pulse width/PRI)(100)

---

**Note** Pulse width is always calculated using mid-threshold.

---

**Risetime** risetime = time at upper threshold–time at lower threshold

**Falltime** falltime = time at lower threshold–time at upper threshold

**Overshoot**  $Overhoot = \frac{(peak - top)}{(top - base)} * 100$

---

**Note** The algorithm will tend to fail for overshoot values exceeding 50%.

---



- V<sub>max</sub>**  $V_{\max}$  = amplitude of the maximum point on screen
- V<sub>min</sub>**  $V_{\min}$  = amplitude of the minimum point on screen
- V<sub>p-p</sub>**  $V_{p-p} = V_{\max} - V_{\min}$  (For voltage only.)
- V<sub>top</sub>**  $V_{\text{top}}$  = most prevalent point above waveform midpoint
- V<sub>base</sub>**  $V_{\text{base}}$  = most prevalent point below waveform midpoint
- V<sub>amp</sub>**  $V_{\text{amp}} = V_{\text{top}} - V_{\text{base}}$  (For voltage only.)
- V<sub>avg</sub>** Average amplitude of the first cycle of the displayed signal is measured. If a complete cycle is not present, the Analyzer will average all data points.
- V<sub>rms</sub>** The rms voltage of the first cycle of the displayed signal is measured. If a complete cycle is not present, the measurement will compute rms on all data points.

$$V_{rms(ac)} = \left\{ 1/n \sum_{j=1}^n V_j^2 - 1/n \sum_{j=1}^n V_j \right\}^{1/2}$$

**A-8 This Page Intentionally Left Blank**

## Index

---

- A** abort Key, 3-130, 3-135
- AC Cal Output, 3-23
- Accessories
  - adapters, 1-6
  - electrical, 1-6
  - mechanical, 1-6
- Accessories Supplied, 1-6
- Acquisition, 3-9
  - single, 3-10
- Acquisition Running, 3-9
- Acquisition Stopped, 3-9
- acquisition test, 3-125
- Address
  - Peak Power Analyzer, 2-1, 2-14
- Addressed, 3-119, 3-120
- Address selection, 2-14
- add to memory Key, 3-104
- after fail Key, 3-115
- Algorithm Definitions, A-4
- Algorithms, A-1
- Amplitude at Time Markers Key, 3-87
- Amplitude Markers, 3-85
- Attenuation, 3-39
  - attenuation menu, 3-129
- Automatic Measurements, A-1
- Automatic Top-Base Measurement, A-2
- Autoscale, 3-12, 3-102
- Auto Trigger, 3-44
- Auto Triggered Scroll, 3-26
- Average Display Mode, 3-77

- B** Bandwidth
  - setting, 3-36, 3-39
- Bandwidth Key, 3-36
- Bench operation, 2-16
  
- C** Cables
  - power, 2-5
- Calibration, 3-107
  - order, 3-127
- Calibrator, 3-22
- Calibrator Switch, 3-22
- cal select Key, 3-133
- Carrier Frequency, 3-89
- Carrier Frequency Menu, 3-89
- Changing the fuse, 2-3
- chan/mem Key, 3-94
- Channel Isolation, 3-42
- channel Key, 3-130, 3-131, 3-134
- Channel Key, 3-35
- Channel Menu, 3-32, 3-33
- Channel Selector Key, 3-89
- Chassis Ground, 3-21
- check source Key, 3-122
- Clear Display Key, 3-10
- Clearing Measurements, 3-110
- clear memory Key, 3-104
- clicker Key, 3-121
- clock Key, 3-59
- CLR MEAS key, 3-110
- Connect Dots Key, 3-80
- Connector
  - AC Cal Output, 3-23
  - DC Cal Output, 3-23
  - Trigger Channel 1 Output, 3-23
  - Trigger Channel 4 Output, 3-23
- Connectors
  - coaxial, 2-7
  - HP-IB, 2-7
  - input, 3-17
  - Peak Power Sensor, 2-8
  - Type-N, 2-8

continue Key, 3-130, 3-135  
continuous Key, 3-111  
Continuous Measurements, 3-111  
coupling Key, 3-39  
CRT, 3-18

**D** Data Entry, 3-15  
DC Cal Output, 3-23  
Default Calibration, 3-137  
Default Settings, 3-4  
Define Measure Menu, 3-107  
Definitions  
    Algorithms, A-4  
Delay, A-4  
    reference point, 3-27  
delay Key, 3-67  
Delay Key, 3-27  
Delay Trigger, 3-41  
Delay Trigger Exercise, 3-68  
Delay Trigger Mode, 3-64  
Description  
    Peak Power Analyzer, 1-4  
Device Under Test, 3-89  
Diagnostics, 3-123  
Display, 3-18  
    axes, 3-80  
    frame, 3-80  
    grid, 3-80  
Displaying Functions, 3-96  
Display Intensity, 3-22  
display Key, 3-93, 3-103, 3-104  
Display Menu, 3-75  
Display Mode  
    average, 3-77  
    envelope, 3-77, 3-102  
    normal, 3-76  
Display Mode Key, 3-76  
Display Screens, 3-96  
Display Units, 3-95  
Documentation, 1-1  
    Getting Started Guide, 1-1

Operating Manual, 1-1  
ordering, 1-2  
Programming Manual, 1-1  
Service Manual, 1-1  
Duty Cycle, A-6

**E** ECL Key, 3-40  
Edge Definition, A-3  
Edge Trigger, 3-41  
Edge Trigger Exercise, 3-46  
Edge Trigger Mode, 3-43  
Electrical Accessories, 1-6  
Entry, 3-15  
    Fine Key, 3-17  
    Knob, 3-17  
    Numeric Keypad, 3-16  
Envelope Display Mode, 3-77  
Environment  
    operating, 2-16  
    storage, 2-17  
EOI Key, 3-120  
Errata, 1-4  
Exercise  
    Delay Trigger, 3-68  
    Edge Trigger, 3-46  
    Pattern Trigger, 3-53  
    State Trigger, 3-60  
    Waveform Math, 3-98  
    Waveform Memory, 3-104  
exit menu Key, 3-121, 3-126, 3-130, 3-136  
external loss Key, 3-37  
External Triggering, 3-42

**F** fail if, 3-115  
Falltime, A-6  
Falltime measurements, A-1  
Fine Key, 3-17, 3-26  
Firmware Revision, 3-117  
form feed Key, 3-121  
Front Panel

- System Control, 3-8
- Front Panel Features, 3-7
- Function
  - display units, 3-95
- Function Key, 3-93
- Function Keys, 3-18
- Functions
  - displaying, 3-96
- Fuse
  - changing, 2-3
  - selection, 2-3

**G** Gain cal, 3-132  
Getting Started Guide, 1-1

**H** Hardcopy Key, 3-10  
holdoff Key, 3-45, 3-52, 3-60  
Horizontal Axis, 3-26  
HP-IB Address, 2-1, 2-14  
HP-IB Connector, 2-7  
HP-IB menu, 3-119

**I** Incoming Inspection, 2-1  
Initial Inspection, 2-1  
Input Connectors, 3-17  
Inspection

- initial, 2-1

  
instr cal menu, 3-132  
Instruments covered by this manual, 1-4  
Intensity

- display, 3-22

  
Intensity Control, 2-10, 3-22  
Interconnections

- Hewlett-Packard Interface Bus, 2-7
- Peak Power Sensor, 2-7

  
Internal Triggering, 3-42

## **K** Key

- abort, 3-130, 3-135
- add to memory, 3-104
- after fail, 3-115
- amplitude at time markers, 3-87
- ampl markers, 3-85
- Bandwidth, 3-36
- cal select, 3-133
- chan/mem, 3-94
- channel, 3-35, 3-130, 3-131, 3-134
- channel selector, 3-89
- check source, 3-122
- clear memory, 3-104
- clicker, 3-121
- clock, 3-59
- CLR MEAS, 3-110
- connect dots, 3-80
- continue, 3-130, 3-135
- continuous, 3-111
- coupling, 3-39
- delay, 3-67
- Delay Key, 3-27
- display, 3-103, 3-104
- Display Mode, 3-76
- ECL, 3-40
- EOI, 3-120
- exit menu, 3-121, 3-126, 3-130, 3-136
- external loss, 3-37
- fail if, 3-115
- form feed, 3-121
- Function, 3-93
- function display, 3-93
- holdoff, 3-45, 3-52, 3-60
- level, 3-45
- marker 1, 3-85
- marker 2, 3-85
- meas/meas def/meas limit, 3-110
- more, 3-39
- nonvolatile, 3-102
- no. of screens, 3-78
- off/frame/axes/grid, 3-80



offset, 3-95  
offset , 3-39  
operand, 3-94  
operator, 3-94  
or if, 3-115  
paper length, 3-121  
pattern, 3-51  
power display, 3-78  
present, 3-60  
probe, 3-38, 3-39  
qualify on, 3-65  
Reference, 3-27  
reference level, 3-36  
save to, 3-115  
sensitivity, 3-95  
sensor zero, 3-37  
set, 3-114  
show status, 3-122  
slope, 3-45  
source, 3-45, 3-103  
standard/user defined, 3-111  
start cal, 3-130, 3-134  
start marker, 3-86  
start test, 3-126  
statistics, 3-111  
stop marker, 3-86  
store, 3-103  
test, 3-114  
thresholds/measurements, 3-112  
Time/Division, 3-26  
Trig'd/auto, 3-44  
trigger on, 3-68  
TTL, 3-40  
vertical scaling, 3-35  
vertical sensitivity, 3-38  
volatile, 3-103  
waveform/pixel, 3-102  
when, 3-51, 3-59  
Window Key, 3-28  
Key-down power-up, 3-4  
Keypad, 3-16, 3-27

Knob, 3-17, 3-27

- L** Level
  - trigger, 3-43
- Level Key, 3-45
- Limit Test, 3-114
- Linear Mode, 3-78
- Line Module, 3-22
- Line Switch, 3-22
- Line Voltage, 2-2
- Line voltage selection, 2-3
- Local Key, 3-10
- Logic Trigger Delay Calibration, 3-137
- Log Mode, 3-36, 3-78
- loop Test, 3-126

- M** Mains Voltage, 2-2
- Maintenance
  - operator's, 2-20
- Making Measurements, 3-107, A-2
- Manual Measurements, 3-83
- Manual Update Package, 1-4
- marker 1, 3-85
- marker 2, 3-85
- Marker Menu, 3-83
- Markers, 3-102
  - amplitude, 3-85
  - time, 3-86
- Mathematical Function, 3-91
- meas/meas def/meas limit Key, 3-110
- Measure Define, 3-111
- Measure Limit, 3-114
- Measurements, 3-107
  - clearing, 3-110
- Measurement Selection, 3-109
- Measurement Setup, A-1
- Measure Sub-menu, 3-111
- Mechanical Accessories, 1-6
- Memory
  - pixel, 3-102

- waveform, 3-102
- Menu
  - Carrier Frequency Menu, 3-89
  - channel, 3-33
  - Define Measure, 3-107
  - Display, 3-75
  - Marker, 3-83
  - Timebase, 3-25
  - Trigger, 3-41
  - Utility, 3-117
  - Waveform Math, 3-91
  - Waveform Memory, 3-101
- Menus, 3-19
- More Key, 3-39
- Mounting
  - rack, 2-16

**N**

- Narrow Pulse, 3-26
- nonvolatile Key, 3-102
- Nonvolatile Memory, 3-102
- Normal Display Mode, 3-76
- Number of screens Key, 3-78
- Numeric Keypad, 3-16

**O**

- offset Key, 3-39, 3-95
- Operating Environment, 2-16
- Operating Manual, 1-1
- Operation
  - bench, 2-16
- Operator Key, 3-94
- Operator's Checks, 2-10
- Operator's maintenance, 2-20
- Option
  - single sensor input, 3-41, 3-93, 3-103, 3-109
- Option 002, 3-21
- Options
  - documentation, 1-5
  - electrical, 1-5
  - miscellaneous, 1-5
- Order of Calibrations, 3-127

or if Key, 3-115  
Overshoot, A-6

**P** Packaging  
    tagging for service, 2-17  
Packaging materials  
    original, 2-17  
    other than original, 2-18  
paper length Key, 3-121  
Pattern Key, 3-51  
Pattern Trigger, 3-41  
    range, 3-52  
    when entered, 3-51  
    when exited, 3-52  
    when Key, 3-51  
    when present, 3-52  
Pattern Trigger Exercise, 3-53  
Pattern Trigger Mode, 3-50  
Persistence, 3-76, 3-80  
Pixel Memory, 3-102, 3-103  
    add to, 3-104  
pixel Menu, 3-103  
position Key, 3-29  
Power Cable, 2-5  
power display Key, 3-78  
Power Requirements, 2-2  
Power-up Sequence, 3-2  
present Key, 3-60  
Preset, 3-4, 3-102  
PRF, A-6  
PRI, A-6  
Probe Attenuation, 3-39  
Probe Attenuation Failure, 3-129  
probe cal Menu, 3-128  
Probe Key, 3-38, 3-39  
Programming Manual, 1-1  
Pulse Offtime, A-5  
Pulse Repetition Frequency, A-6  
Pulse Repetition Interval, A-6  
Pulse width, A-5

- Q** Qualify  
    edge, 3-66  
    pattern, 3-66  
    state, 3-66  
Qualify on Key, 3-65
- R** Rack Mounting, 2-16  
ram Test, 3-125  
Rear Panel Connector, 3-21  
Rear Panel Sensor Input, 3-21  
Recall Key, 3-14  
Recommended Test Equipment, 1-7  
reference Key, 3-27  
Reference Key, 3-27  
reference level Key, 3-36  
Reference Point, 3-27  
Reset, 3-4  
Risetime, A-6  
Risetime measurements, A-1  
rom Test, 3-125  
Run/Stop Key, 3-9
- S** Safety, 1-2  
Safety Considerations, 1-2  
Save Key, 3-14  
save to Key, 3-115  
Screens, 3-78  
Scroll Trigger Mode, 3-26  
Selftest, 3-123  
selftest menu, 3-123  
sensitivity Key, 3-95  
Sensor Check Source, 3-18  
    adapters, 1-6  
sensor zero Key, 3-37  
Serial Number, 1-4  
Service Manual, 1-1  
service menu, 3-136  
set Key, 3-114  
Setup  
    Autoscale Key, 3-12

- Recall Key, 3-14
- Save Key, 3-14
- Show Key, 3-14
- Shipment, 2-17
- Show Key, 3-14
- show status Key, 3-122
- Signal Noise, 3-77
- Single Key, 3-10
- Single Sensor Input Option, 3-41, 3-93, 3-103, 3-109
- slope Key, 3-45
- Slow Sweep Speeds, 3-26
- Softkeys, 3-18
- source Key, 3-45, 3-103
- Specifications, 1-2, 1-8-14
  - supplemental, 1-2
  - warranted, 1-2
- Standard Measurements, 3-111
- standard/user defined Key, 3-111
- start cal Key, 3-130, 3-134
- start marker, 3-86
- start test Key, 3-126
- State Trigger, 3-41
- State Trigger Exercise, 3-60
- State Trigger Mode, 3-58
- statistics Key, 3-111
- stop marker, 3-86
- Storage, 2-17
- store Key, 3-103
- Submenu
  - attenuation, 3-129
  - time null, 3-131
- Supply Voltage, 2-2
- Sweep Speed, 3-26
- Switch
  - calibrator, 3-22
- System Control, 3-8
  - Clear Display Key, 3-10
  - Hardcopy Key, 3-10
  - Local Key, 3-10
  - Run/Stop Key, 3-9
  - Single Key, 3-10

**T** Tagging for Service, 2-17  
Talk Only, 3-119, 3-120  
Test  
    loop, 3-126  
Test Equipment, 1-7  
test Key, 3-114  
thresholds/measurements Key, 3-112  
Timebase Menu, 3-25  
    delay Key, 3-27  
    reference Key, 3-27  
    Time/Div Key, 3-26  
    Window Key, 3-28, 3-29  
Timebase Window, 3-93  
Time/Division, 3-26  
time Key, 3-131  
Time Markers, 3-86  
time null submenu, 3-131  
Trig'd/auto Key, 3-44  
Trigger  
    delay, 3-41  
    Delay, 3-64  
    edge, 3-41, 3-43  
    pattern, 3-41, 3-50  
    state, 3-41, 3-58  
Trigger Channel 1 Output, 3-23  
Trigger Channel 4 Output, 3-23  
Triggered Scroll, 3-26  
Trigger Event, 3-27  
Triggering  
    externally, 3-42  
    internally, 3-42  
Trigger Level, 3-43, 3-45  
Trigger Menu, 3-41  
trigger on Key, 3-68  
Trigger Source, 3-45  
Trigger Threshold, 3-43  
TTL Key, 3-40  
Turn-on, 3-1  
Turn-on Procedure, 3-2

- U** Units
  - function, 3-95
  - Units Selection, 3-35
  - User-defined Pulse width, A-5
  - Utility Menu, 3-117
  
- V**  $V_{amp}$ , A-7
  - $V_{avg}$ , A-7
  - $V_{base}$ , A-7
  - Verification
    - instrument, 2-10
  - Vertical Position, 3-39
  - Vertical Scaling Key, 3-35
  - Vertical Sensitivity, 3-35
  - Vertical Sensitivity Key, 3-38
  - $V_{max}$ , A-6
  - $V_{min}$ , A-7
  - volatile Key, 3-103
  - Volatile Memory, 3-103
  - $V_{p-p}$ , A-7
  - $V_{rms}$ , A-7
  - $V_{top}$ , A-7
  
- W** Waveform Math Exercise, 3-98
  - Waveform Math Menu, 3-91
  - Waveform Memory, 3-102
  - Waveform Memory Exercise, 3-104
  - Waveform Memory Menu, 3-101
  - waveform/pixel Key, 3-102
  - when Key, 3-59
  - window Key, 3-28
  - Window Key
    - position Key, 3-29
    - timebase Key, 3-29
  - Windows
    - functions, 3-79
    - timebase window, 3-79
  
- Z** Zeroing, 3-37